



# FOREVER REDWOOD

*From the Forest, For the Forest since 1995*







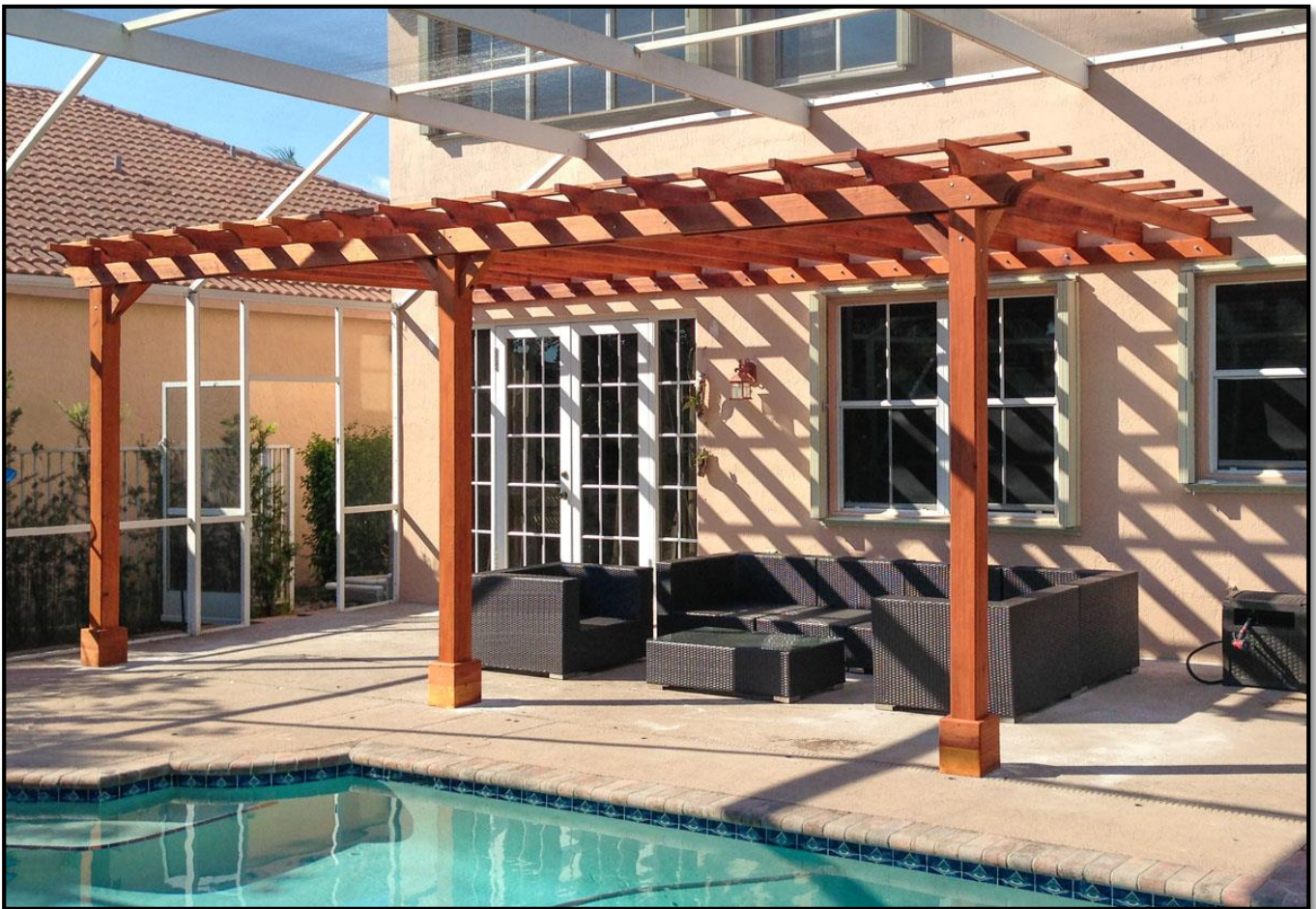



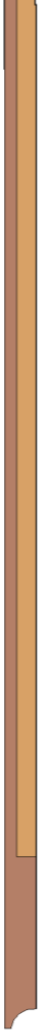

---

866.332.2403 (TOLL FREE); 7am – 7pm Pacific Time, Monday-Saturday

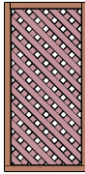
## ASSEMBLY INSTRUCTIONS FOR THE **ATTACHED GARDEN PERGOLA WITH LEDGER BOARD**







**CONTENT OF BOXES**

Note	Description	Drawing	No.
Quantity will vary.	Posts		1
Quantity will vary.	Single Supports		2
Quantity will vary.	Supports with In-Between Blocking		3
Quantity will vary.	Rafters		4
Quantity will vary.	Main Knee Braces		5
Quantity will vary.	Secondary Knee Braces		6
Quantity will vary.	Slats		7
Quantity will vary	Roof Lattice panels <b>If ordered.</b>		8
Quantity will vary.	Boots		9
Quantity will vary.	Ledger Board		10
Quantity will vary.	Trims		11
Quantity will vary.	Standard, Gale Wind or Hurricane Anchors Bases. <b>If ordered.</b>		Standard
			Gale Wind
Quantity will vary.	Angles		13

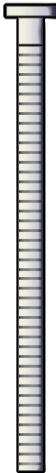
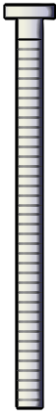
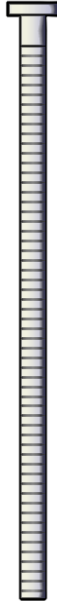
**Note:** Part numbers in the Content of Boxes Table are for reference only. These do not match to the numbers marked on the parts sent.

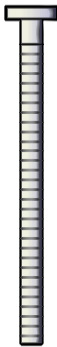
## HARDWARE LIST

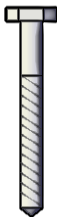
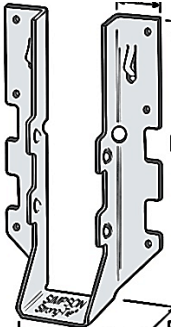
Description	Drawing	No.
<p>3/8" X 7" Bolts (To attach the supports to the post / To attach the supports together).</p>		A
<p>3/8" X 6" Bolts (To attach the rafters to the posts)</p>		B
<p>3/8" X 9" Bolts (To attach the knee braces to the posts)</p>		C
<p>3/8" X 12" Bolts (To attach the main knee braces to the central post).</p>		D
<p>5/16" X 5" Bolts (To attach the secondary knee braces to the rafters).</p>		E
<p>3" Deck Screws (To attach the rafters to the supports / To attach the slats to the rafters / To attach the boots to the posts / To attach the lattice panels roof to supports).</p>		F
<p>1/2" X 4" Anchor Bolts (To attach the anchor bases to the ground / To attach the ledger board to the wall).</p>		G
<p>5/16" X 3" Lag Bolts (To attach the anchor bases to the posts)</p>		H
<p>Joist Hanger <b>If ordered.</b></p>		I

*Note: Dimensions of your hardware will vary depending on size.*

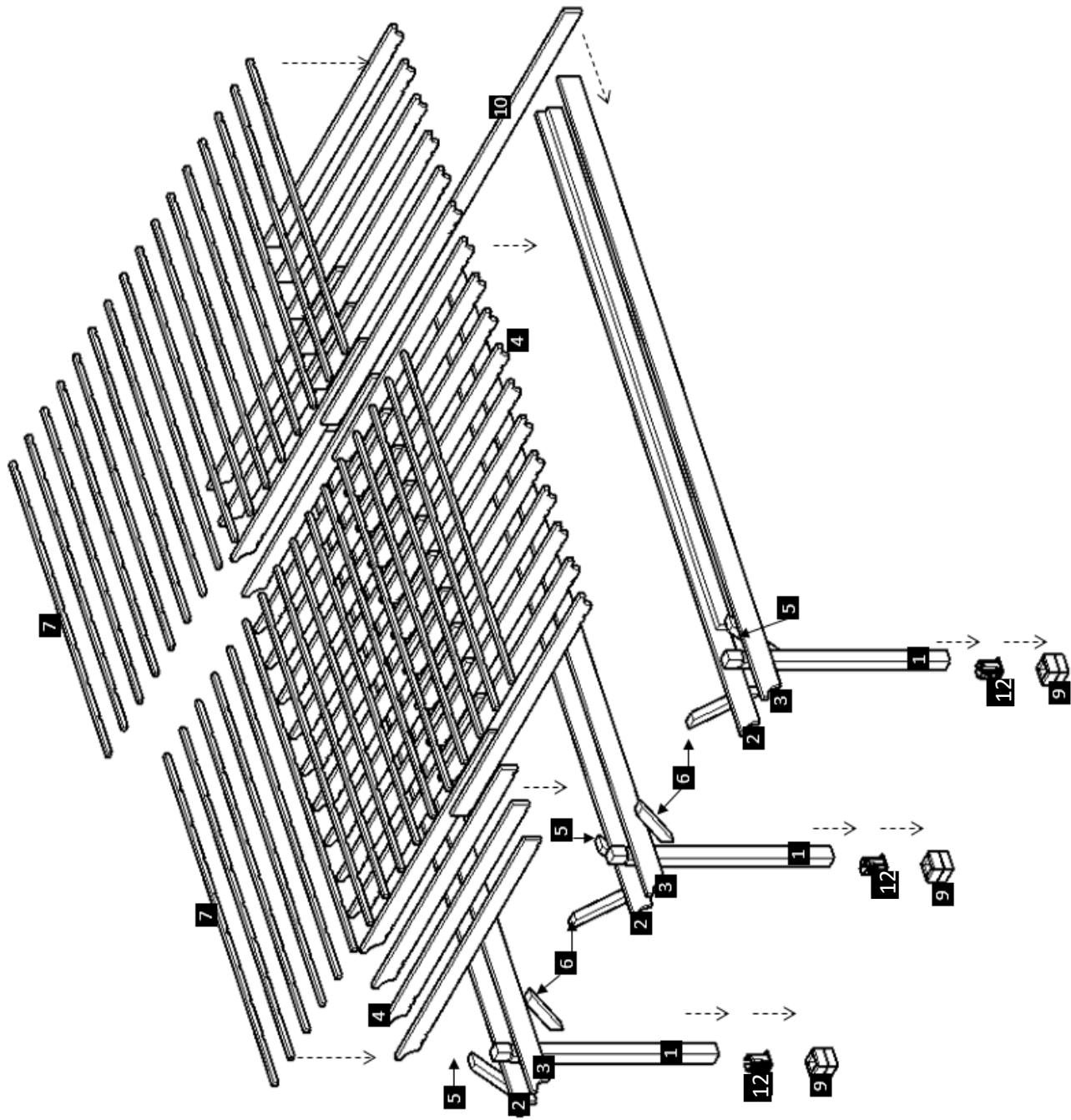

DESCRIPTION	No
Posts	1
Single Supports	2
Supports with In-Between Blocking	3
Rafters	4
Main Knee Braces	5
Secondary Knee Braces	6
Slats	7
Roof Lattice Panels	8
Boots	9
Ledger Board	10
Trims	11
Anchor Bases	12
Angles	13

**Note:** Part numbers in the Drawing are for reference only. These do not match to the numbers marked on the parts sent.

**NOTE:** In order to know where the post needs to be placed, check the numbers on them. If the post is not marked, then place the single Supports on the ground to locate the markings for each post position and clearly set your bearings. (“Don’t attach yet, only place them on the ground to begin with”).

**Step 1:** Install the anchor base (12) with ½" X 4" anchor bolts (G) or lag bolts. Please see the “How to anchor your pergola document” for all details. Set your post (1) in the saddle of the anchor bases (12). Drill a ø ¼" hole in the post prior to anchoring to facilitate the ratcheting of the hardware. After that, use a 5/16" X 3" lag bolts (H) to attach each post to the its respective anchor base (12).

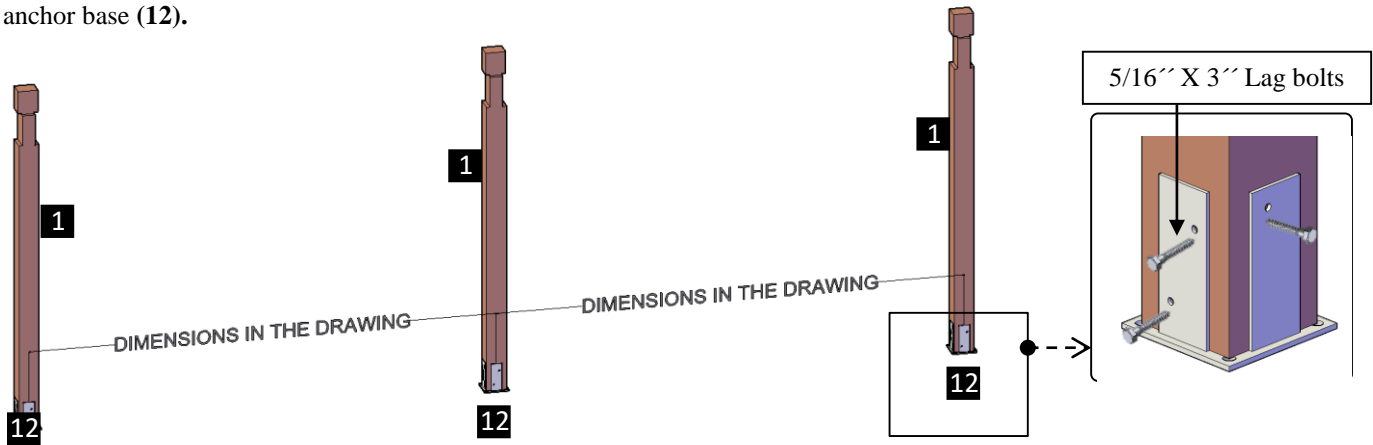

**Step 2:** Attach the ledger board (10) to the wall with ½" X 4" anchor bolts (G) (for concrete wall) or lag bolts (for wood wall). A lag bolts or anchor bolts every 16" is enough.

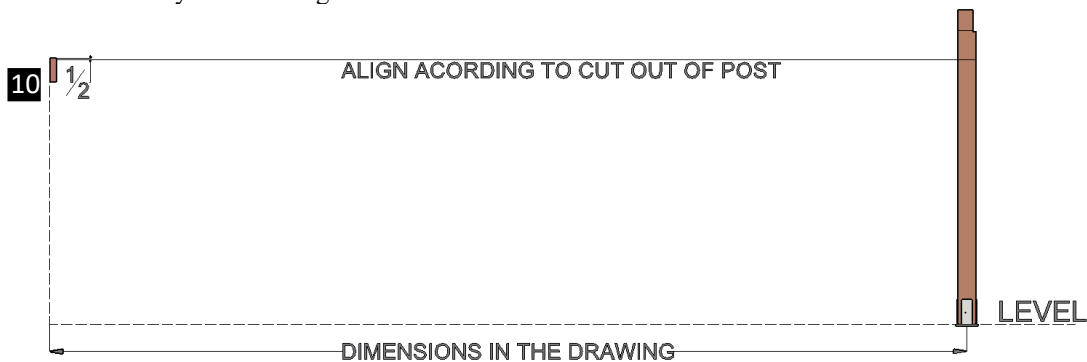

**Step 3:** First attach the single supports (2) to the posts with 3/8" X 7" bolts (A). After that, place the supports with in-between blocking (3) into the post notches as show and attach to the post with the single support bolts. Each part has a series of numbers that indicate where to attach the part with the corresponding number.

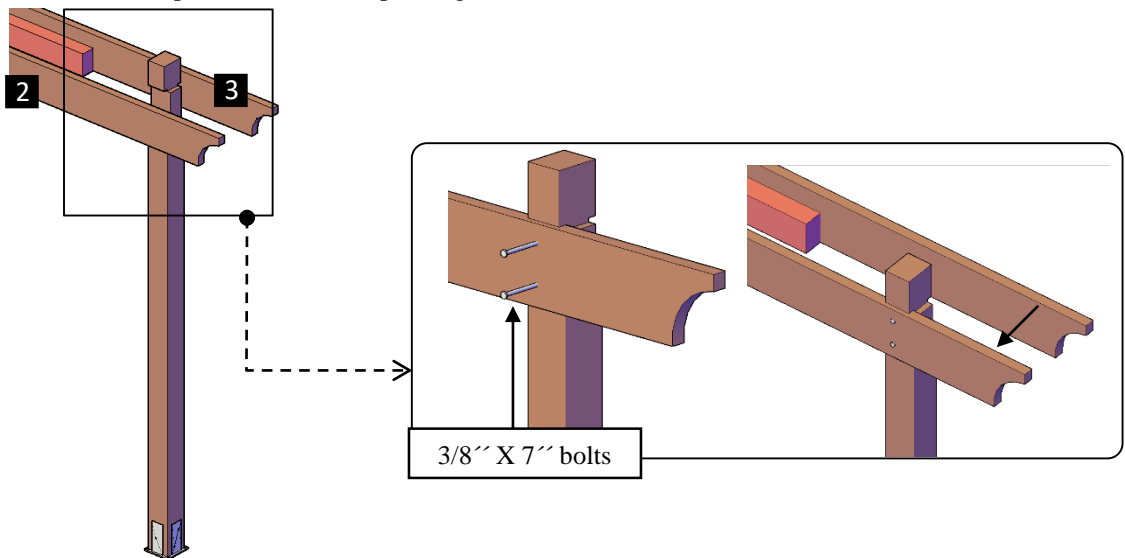

**Step 4:** Attach the single supports (2) to the supports with in-between blocking (3), use 3/8" X 7" bolts (A). The quantity of bolts depends on the length of the supports.

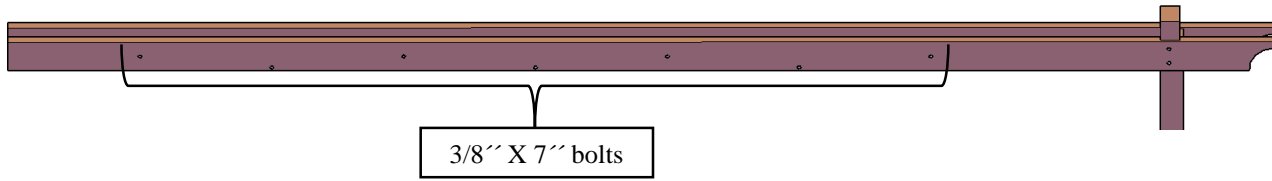

**Step 5:** Use 3" screws to attach the supports to the ledger board (10). After that, attach the angles (13) to the supports and to the ledger board (10) with lag bolts. Finally, cover the angles with the trims, use 3" screws (11) to attach.

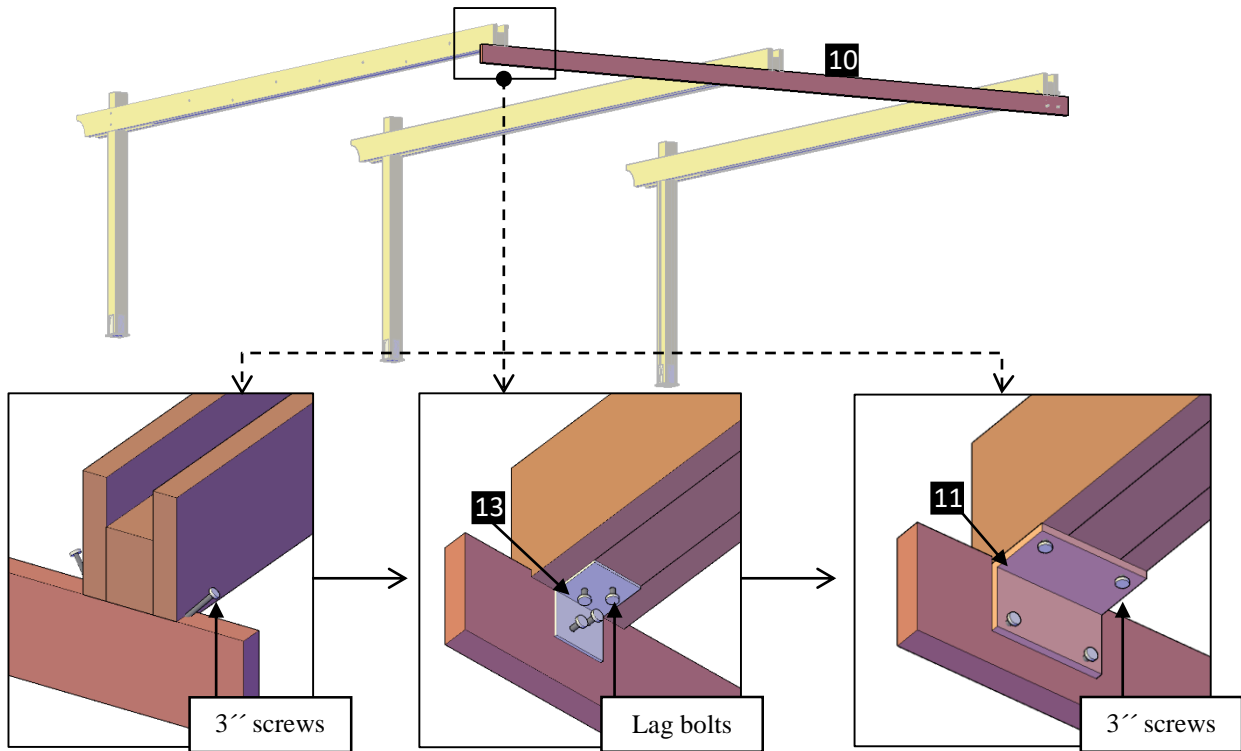

**Step 6:** Use 3/8" X 6" bolts (B) to attach the rafters (4) to the posts. Each part has a series of numbers that indicate where to attach the part with the corresponding number.

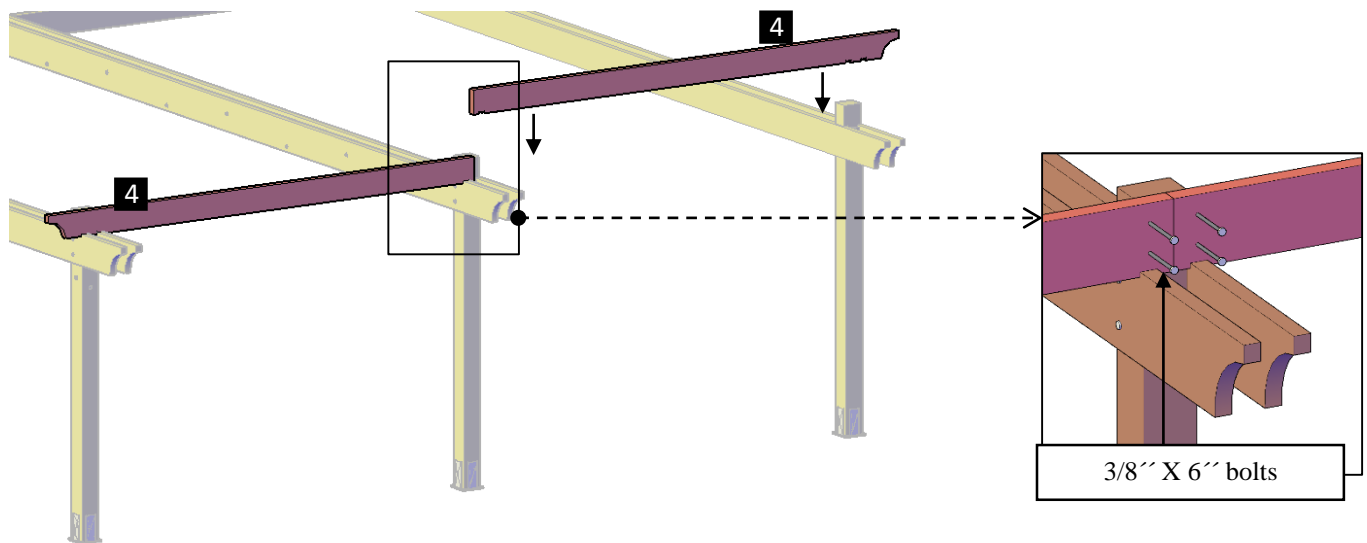

**Step 7:** Attach the knee braces to the post, supports and rafters as is shown below. Each part has a series of numbers that indicate where to attach the part with the corresponding number.

**7.1:** Attach the knee braces (5,6) to the post with 3/8" X 9" bolts (C).

**7.2:** Attach the secondary knee braces (6) to the central post using 3/8" X 12" bolts (D).

**7.3:** Use 3/8" X 7" bolts (A) to attach the main knee braces (5) to the supports.

**7.4:** Use 5/16" X 5" bolts (E) to attach the secondary knee braces (6) to the rafters.

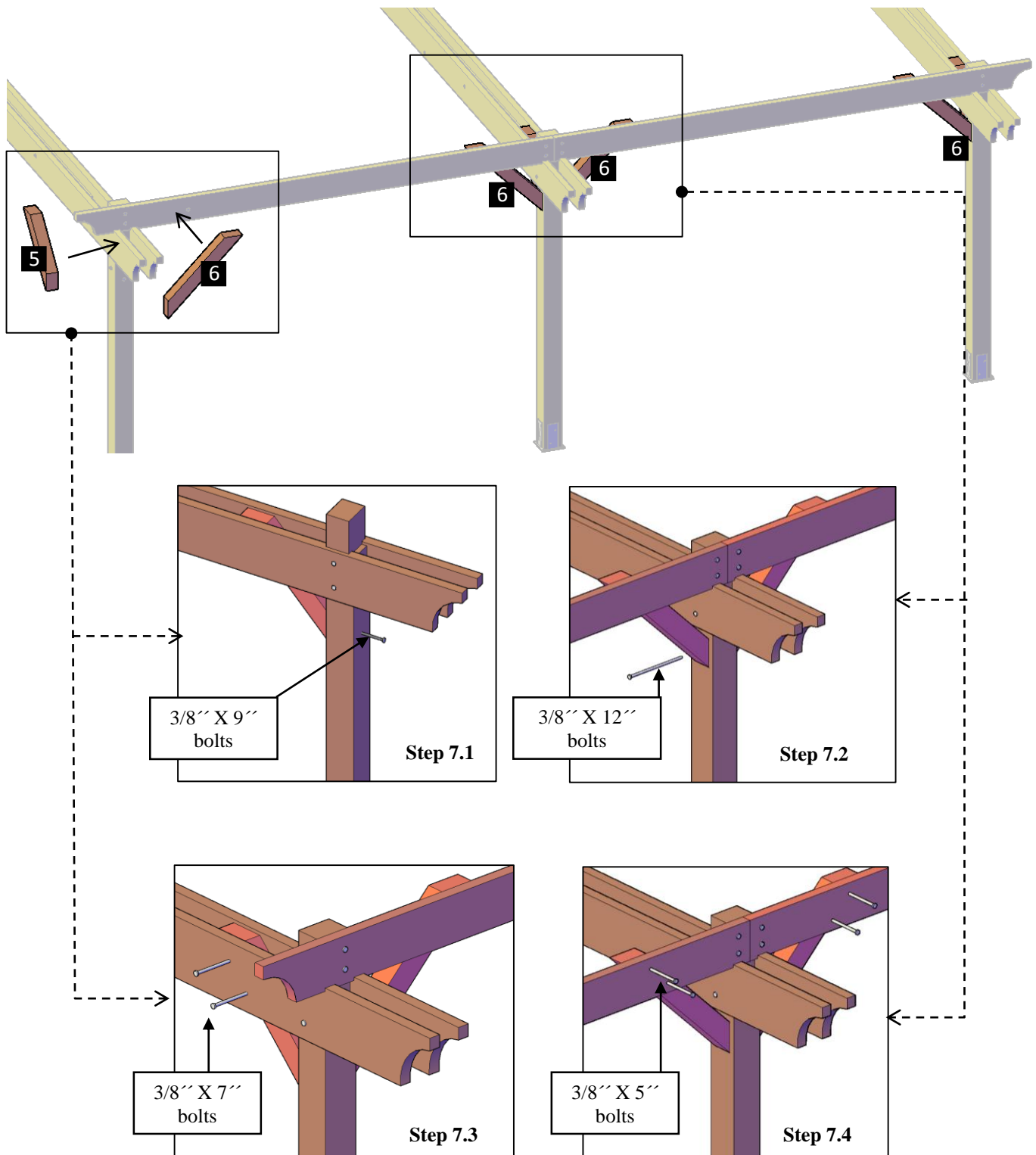

**Option A – With Rafters and Slats.**

**Step 8:** Use 3'' screws (F) to attach the rafters (4) to the supports. Each part has a series of numbers that indicate where to attach the part with the corresponding number.

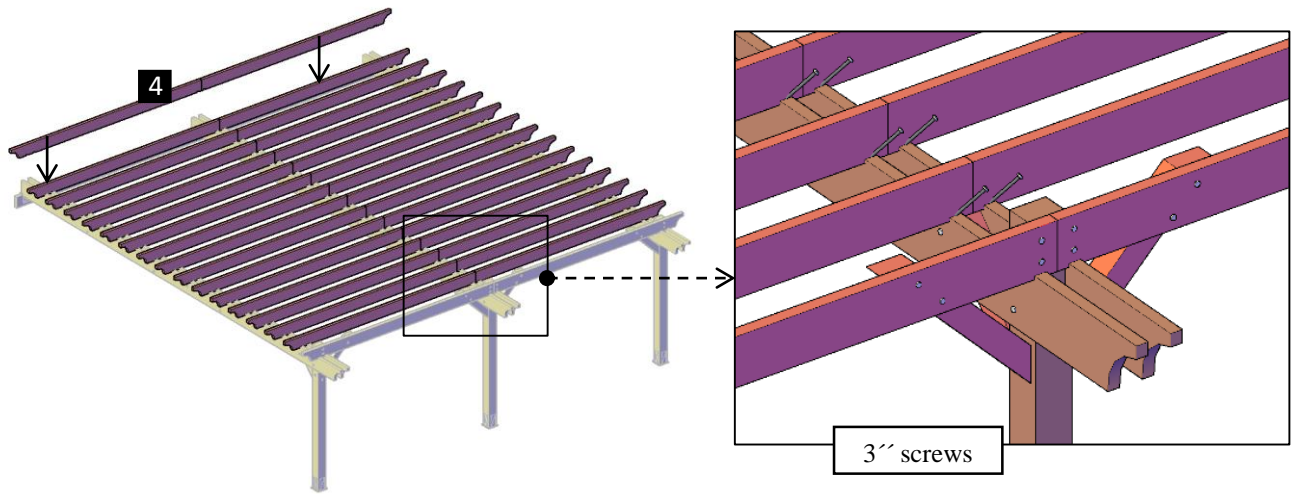

**Step 9:** Use 3'' screws (F) to attach the slats (7) to the rafters. Each part has a series of numbers that indicate where to attach the part with the corresponding number.

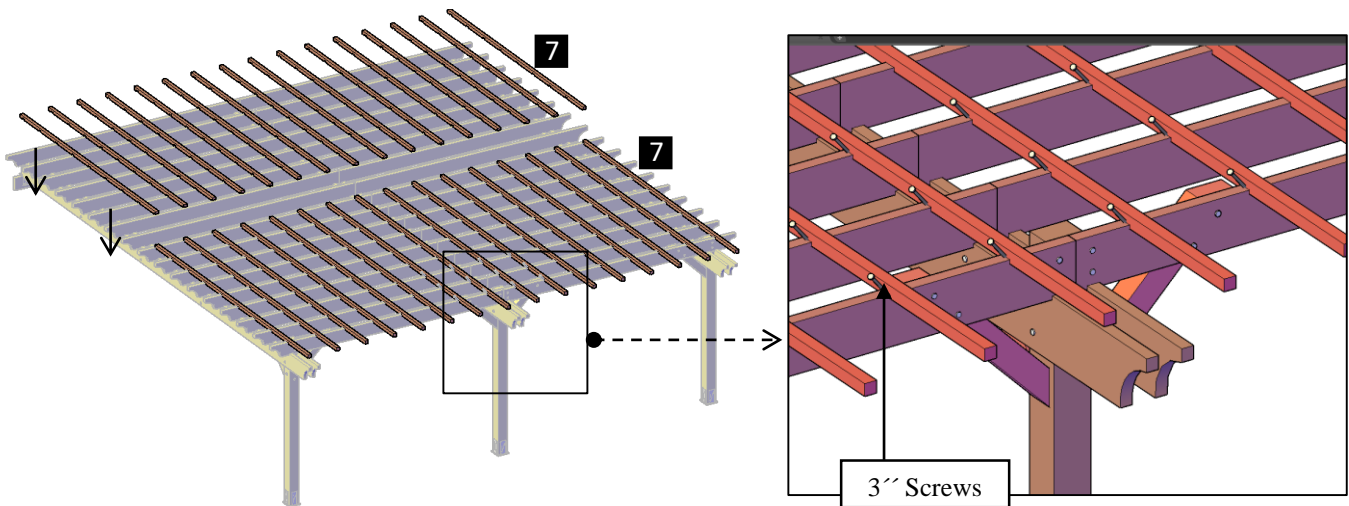

**Step 10:** Use 3'' screws (F) to attach the boots (9) to the posts.

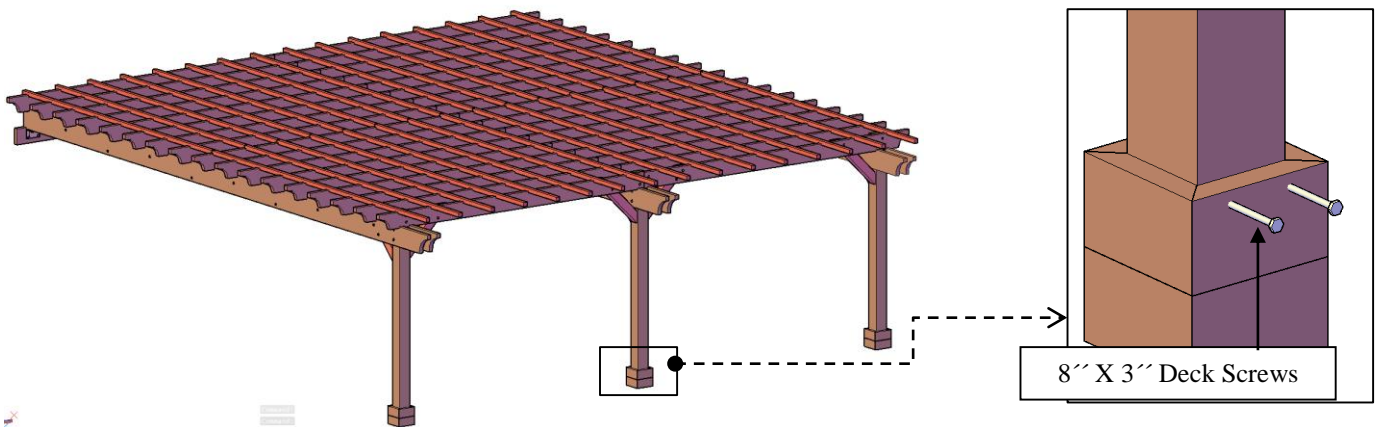



## Option B – With Lattice Panels.

**Step 11:** Check you set of drawings and see if on the center top, there is a lattice panel or a rafter. You must attach this piece with 3'' screws. Each part has a series of numbers that indicate where to attach the part with the corresponding number.

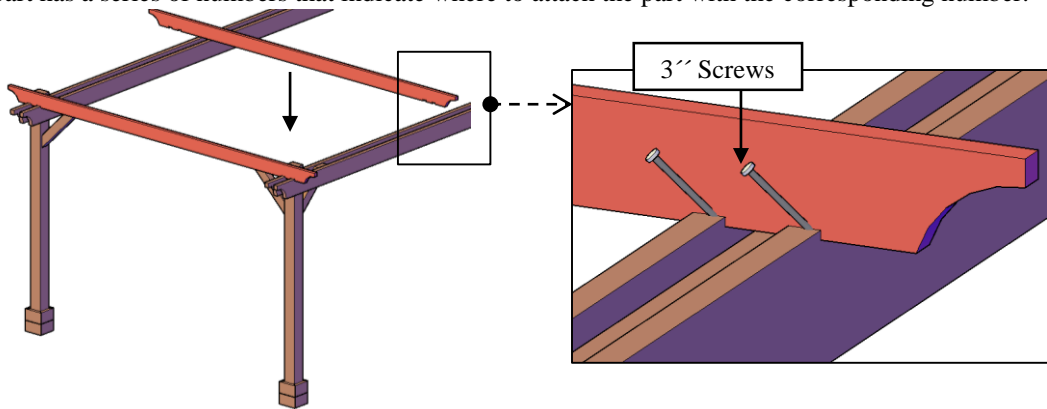

**Step 12:** Continue attaching the side panels and the rafters. Use the deck screws supplied. Attach the roof lattice panels (8) to the supports and to the sides of the rafters. A screw every 2 or 3 feet is enough. Each part has a series of numbers that indicate where to attach the part with the corresponding number.

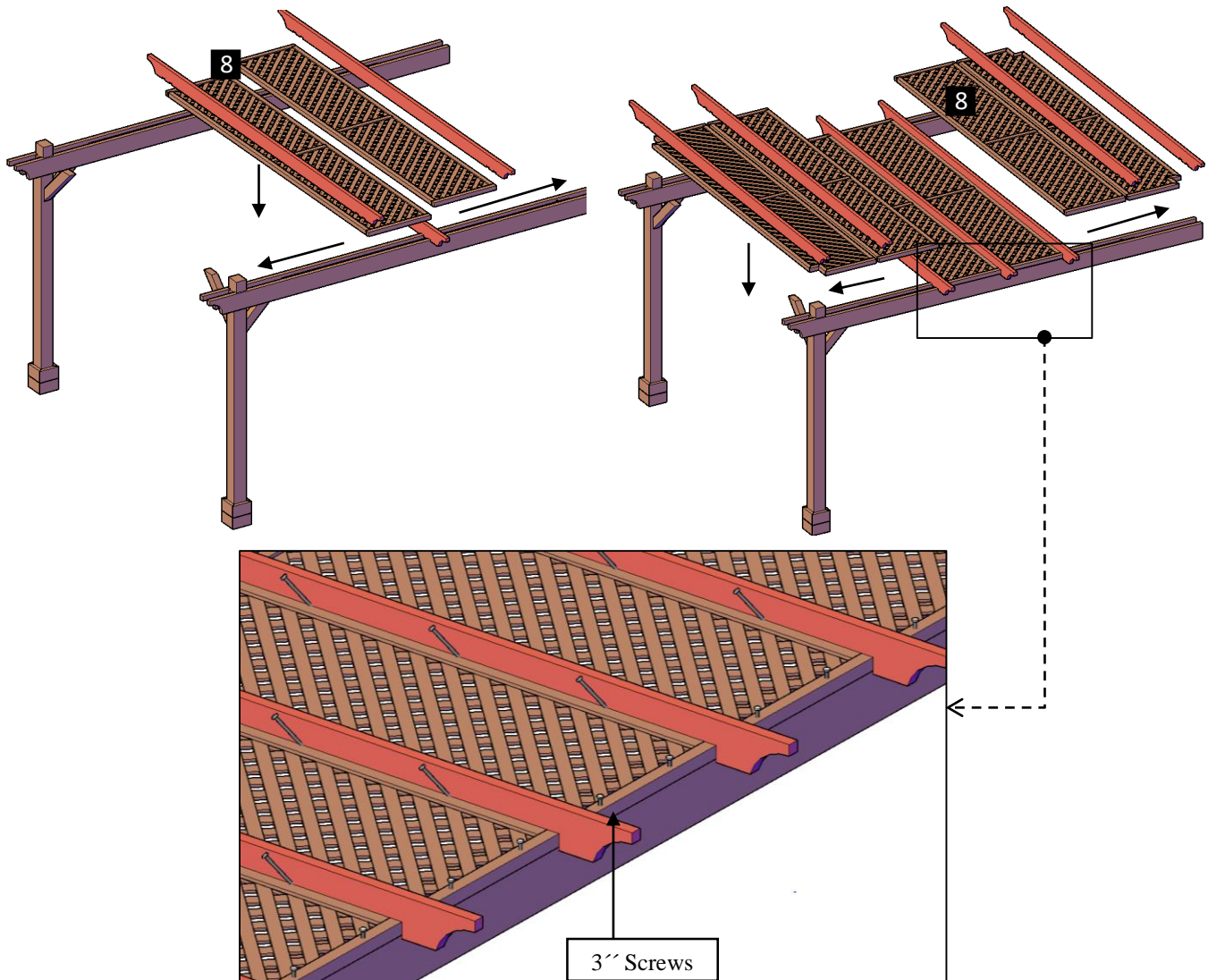



*This completes the Pergola assembly. Hope you enjoy your set for many decades. If you ever have a problem or a question, don't hesitate to call us (866 332 2403) or email us. We are here to support you.*

## HOW TO REMOVE THE ELECTRICAL WIRING TRIM FROM THE POST?

**Step 1:** First remove the deck screws to remove the boots of the post.

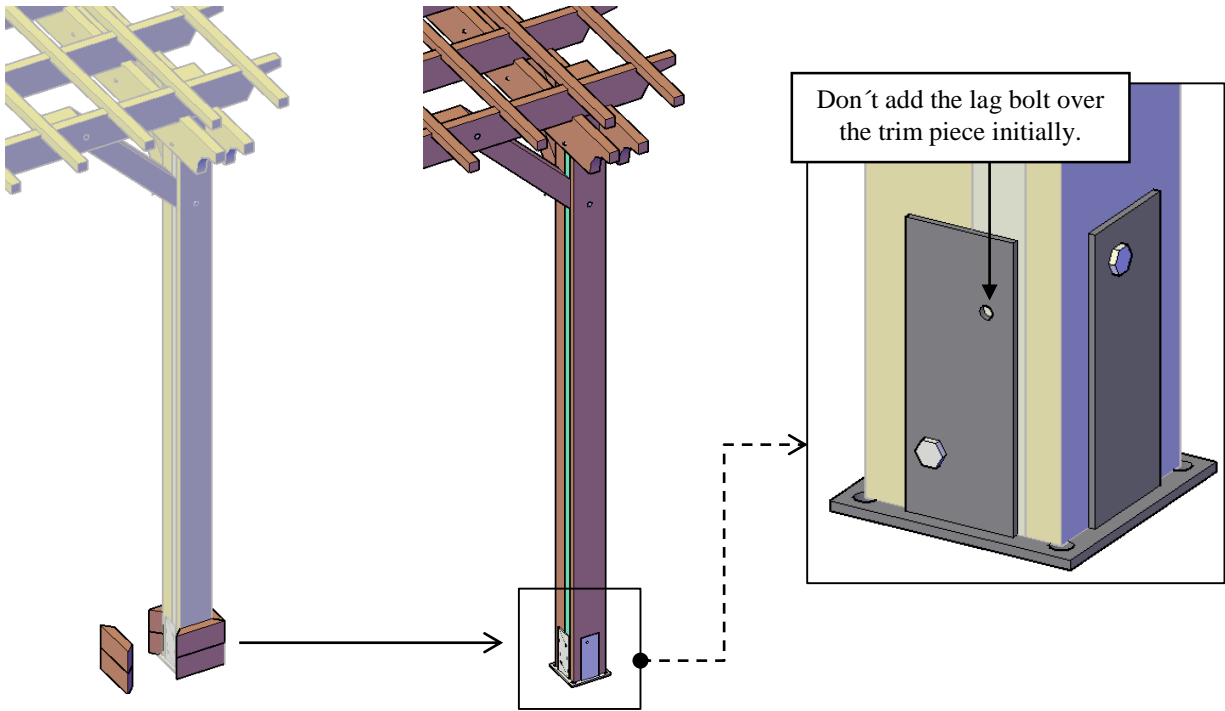

**Step 2:** Loosen the nut on the bolt rafter.

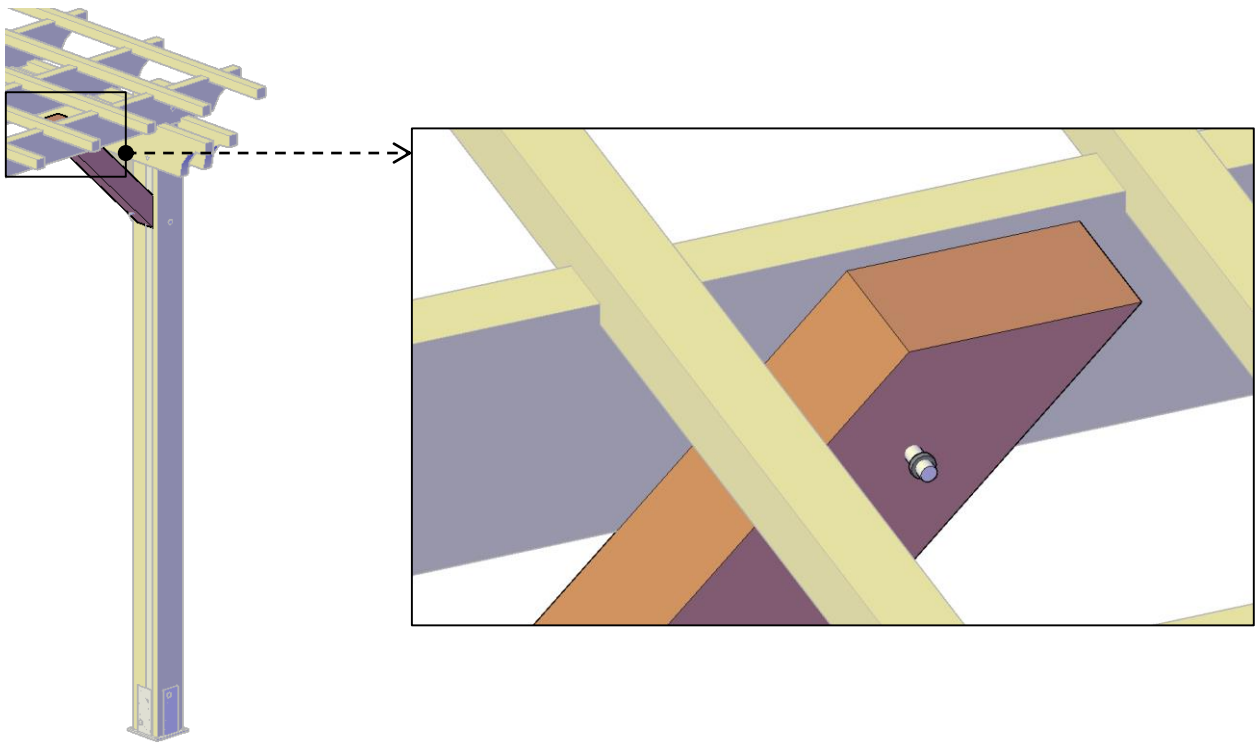

**Step 3:** The bolt of the post and the brace must be flush with the post.

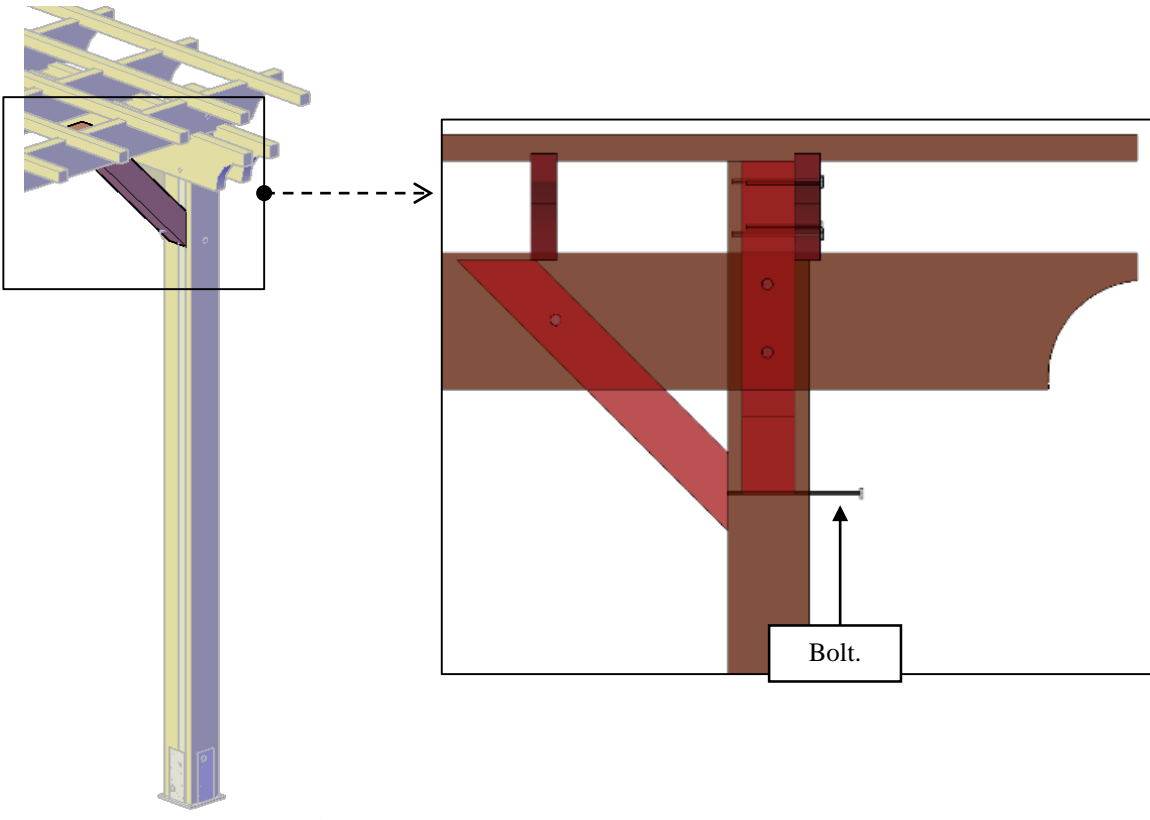

**Step 4:** Swing the brace aside. After that, remove the trim.

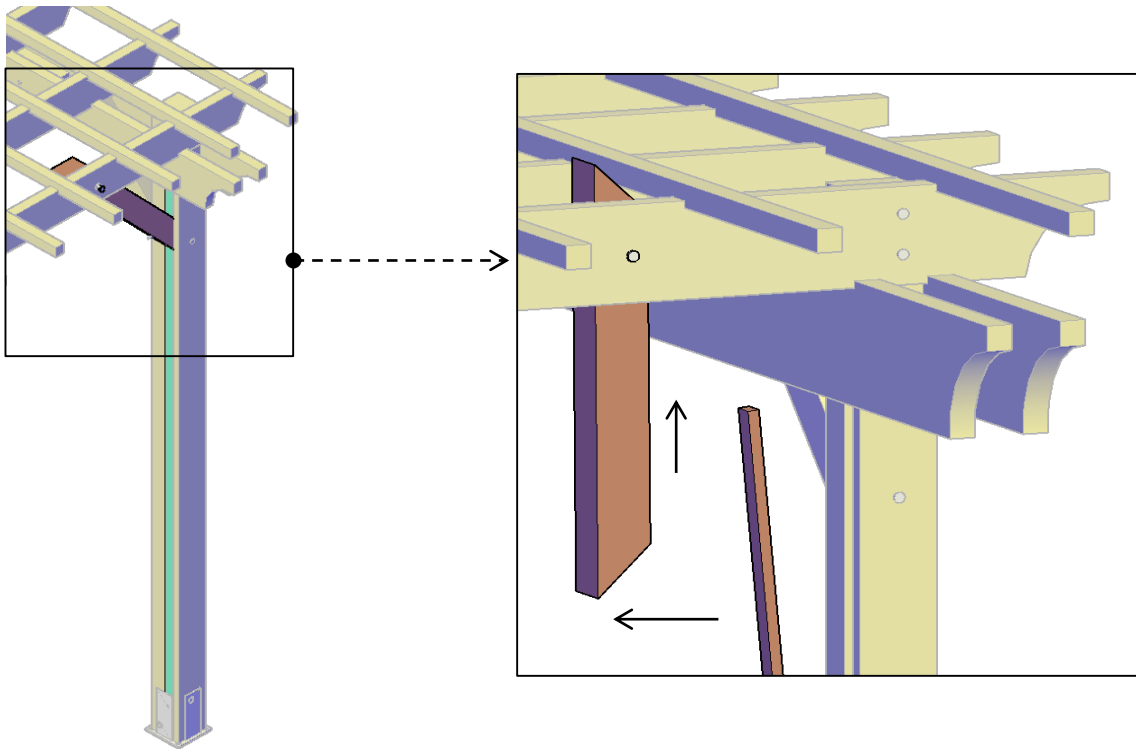

*Note: The dimensions of the trim are standard, adjust if necessary.*