



FOREVER REDWOOD

From the Forest, For the Forest since 1995



866.332.2403 (TOLL FREE); 7am – 7pm Pacific Time, Monday-Saturday

ASSEMBLY INSTRUCTIONS FOR THE REDWOOD COCKTAIL BAR STOOL



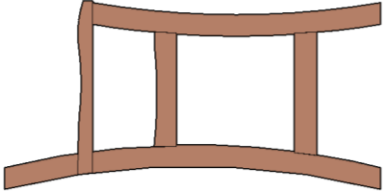
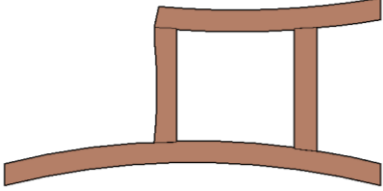
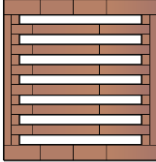
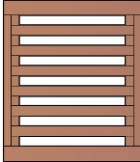
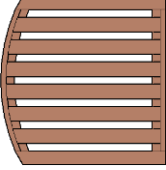
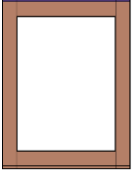

CONTENT OF BOXES

Qty.	Description	Drawing		No.
2	Legs (With arms or armless)			1
1	Seat			2
1	Backrest (Standard or Luna)			3
1	Base Support			4
2	Diagonal Supports			5

Note: Part numbers in the Content of Boxes Table are for reference only. These do not match to the numbers marked on the parts sent.



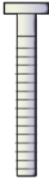
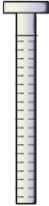

HARDWARE LIST

Description	Drawing	No.
5/16" X 3 1/2" Bolts (To attach the seat, the backrest and the base support to the legs. / To attach the diagonal supports to the seat).		A
5/16" X 4 1/2" Bolts (To attach the diagonal supports to the legs).		B

Note: Dimensions of your hardware will vary depending on size.



DESCRIPTION	No
Legs	1
Seat	2
Backrest	3
Base Support	4
Diagonal Supports	5

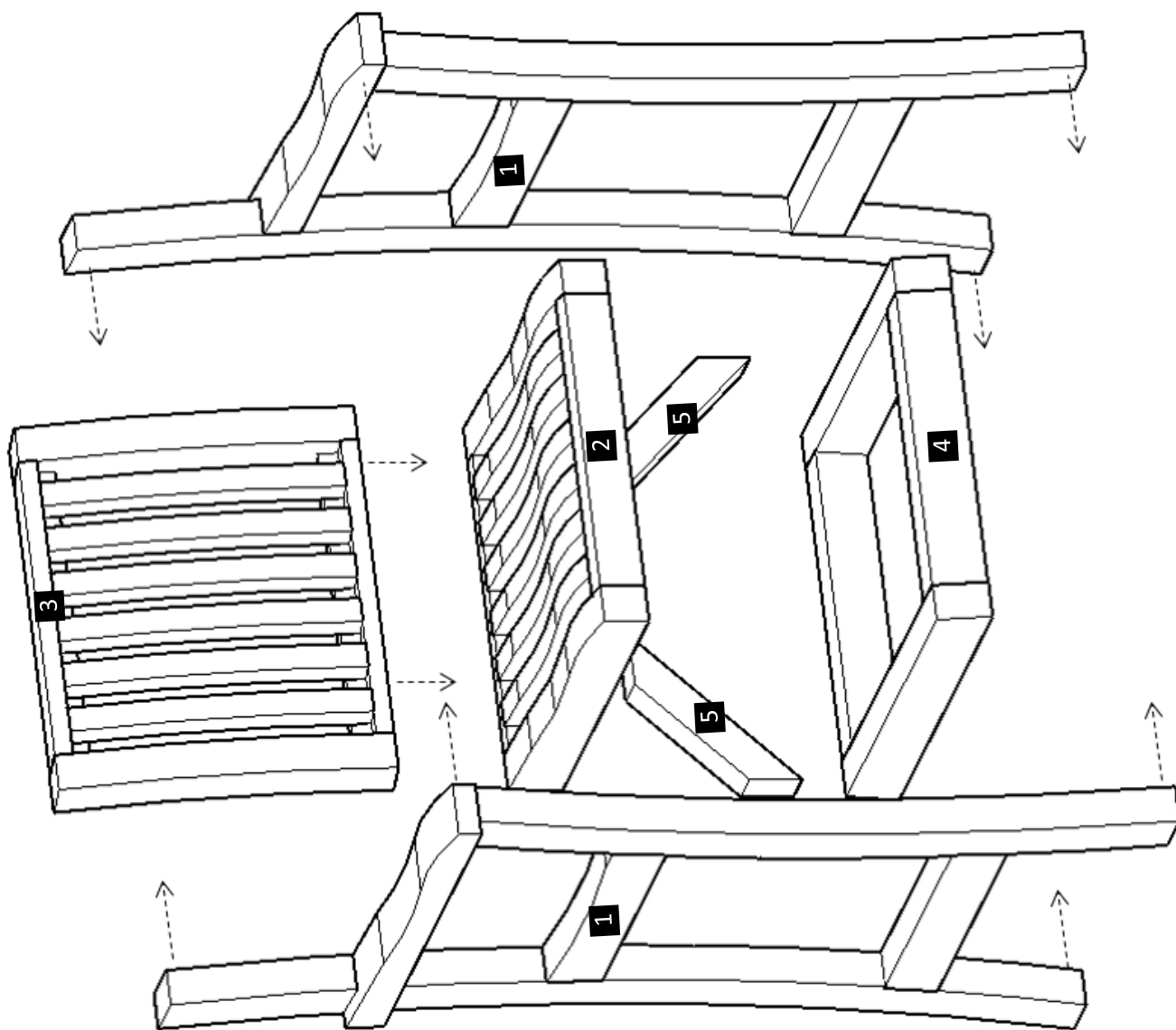

Note: Part numbers in the Drawing are for reference only. These do not match to the numbers marked on the parts sent.

Step 1: Use 5/16" x 3 1/2" bolts (A) to attach the legs (1) to the seat (2). Each part has a series of numbers that indicate where to attach the part with the corresponding number.

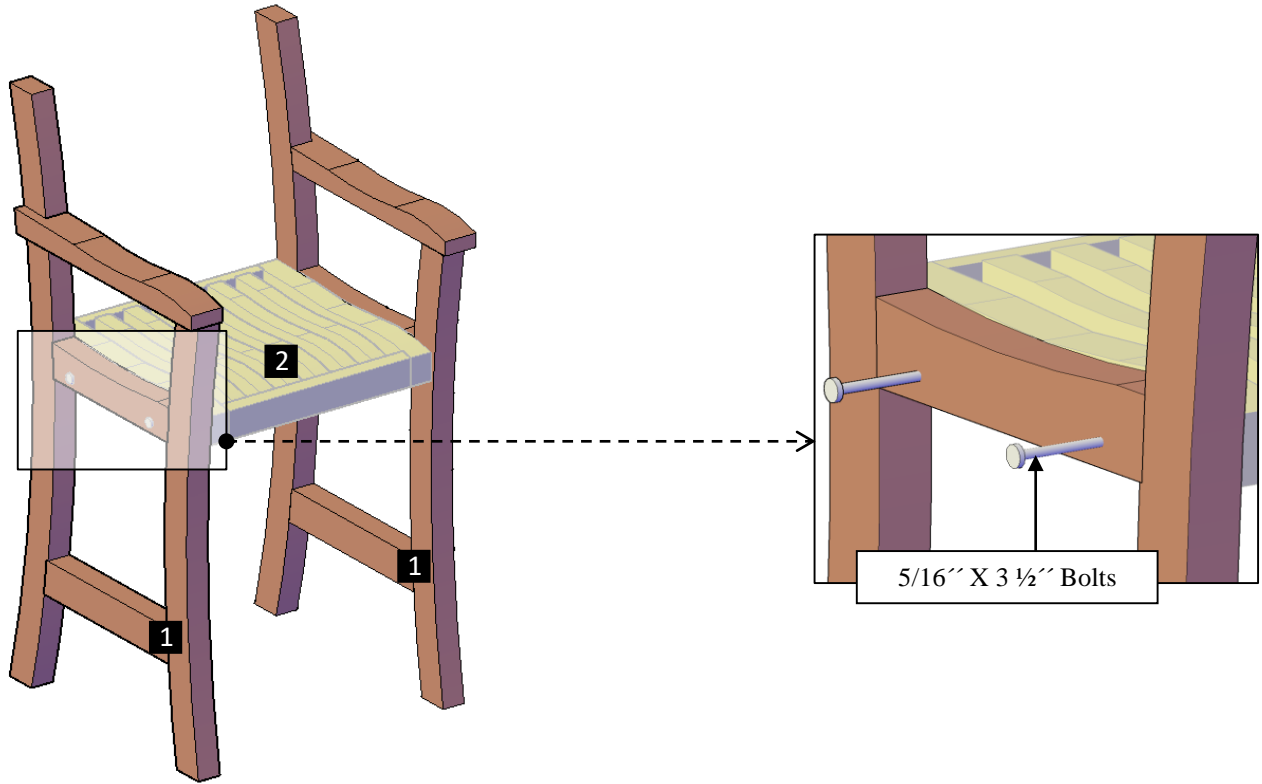

Step 2: Attach the backrest (3) to the legs with 5/16" x 3 1/2" bolts (A). Each part has a series of numbers that indicate where to attach the part with the corresponding number.

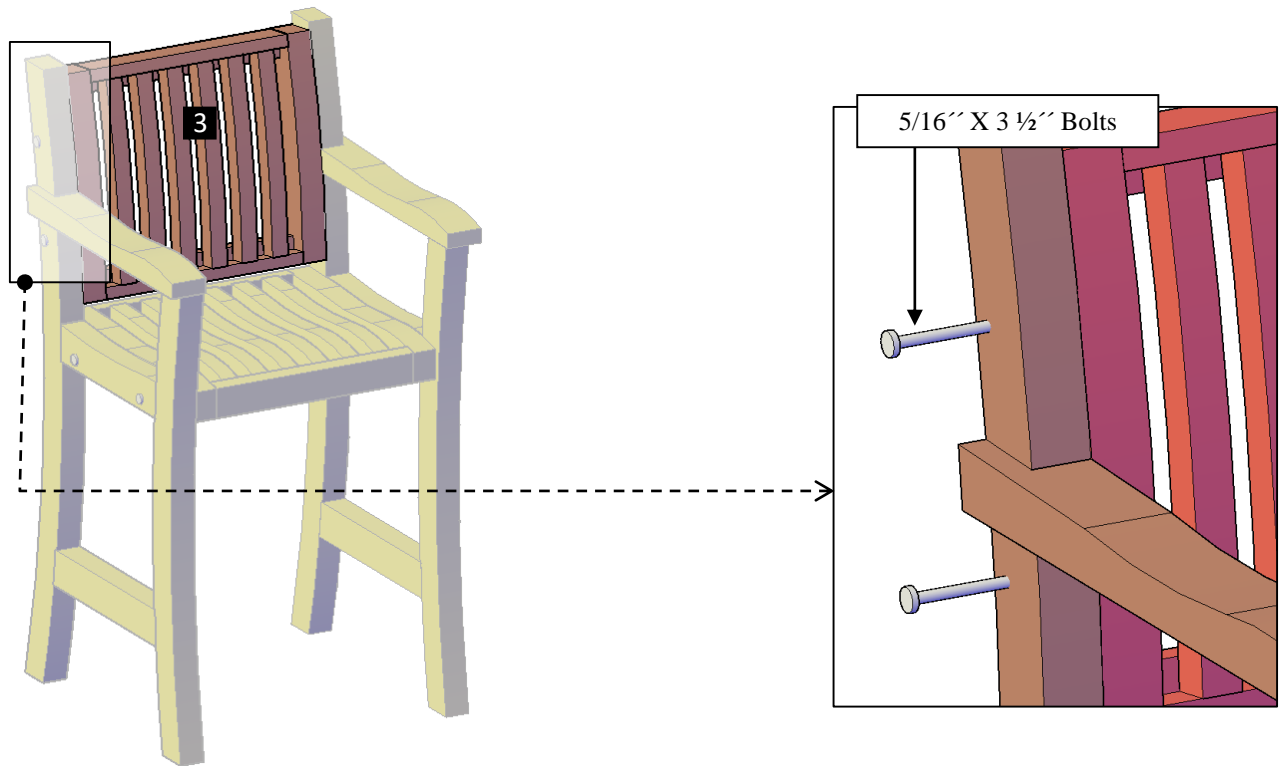

Step 3: Attach the base support (4) to the legs with 5/16" x 3 1/2" bolts (A). Each part has a series of numbers that indicate where to attach the part with the corresponding number.

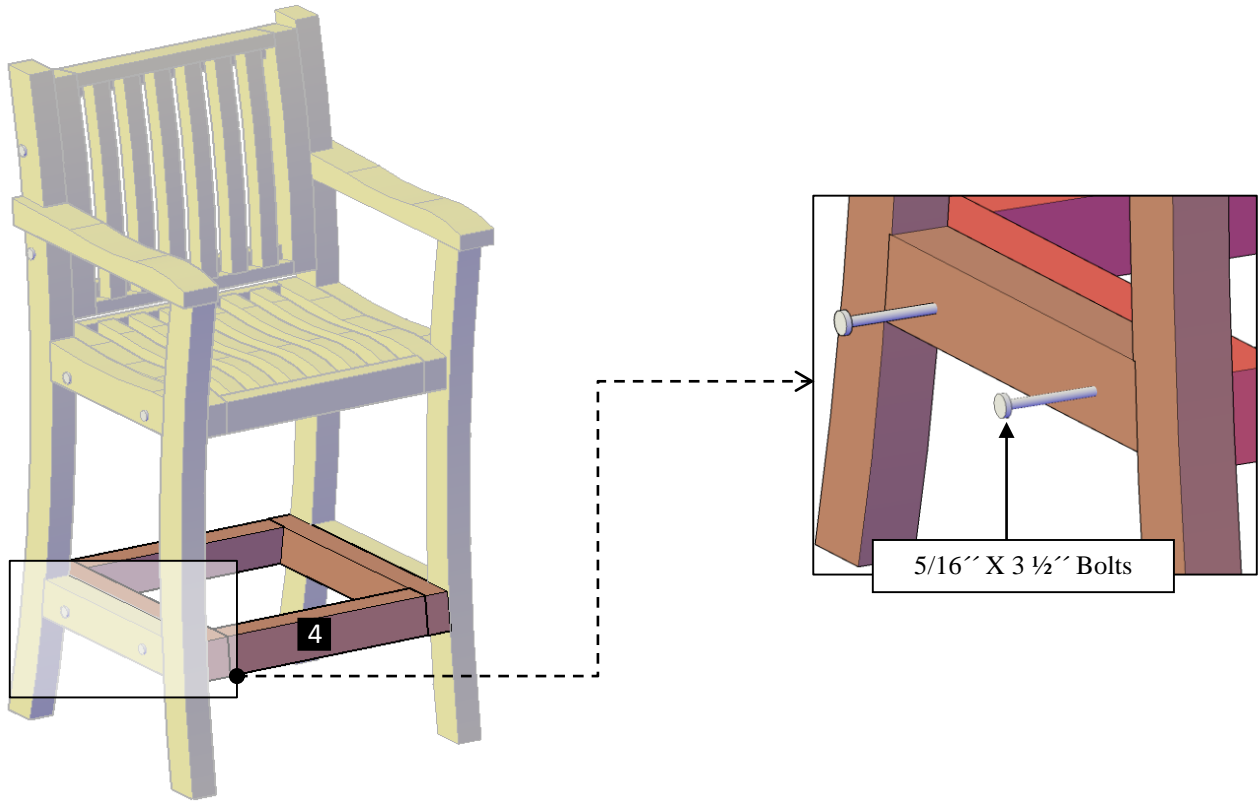

Step 4: Finally, use 5/16" x 3 1/2" bolts (A) to attach the diagonal supports (5) to the seat. After that, use 5/16" x 4 1/2" (B) bolts to attach to the legs. Each part has a series of numbers that indicate where to attach the part with the corresponding number.

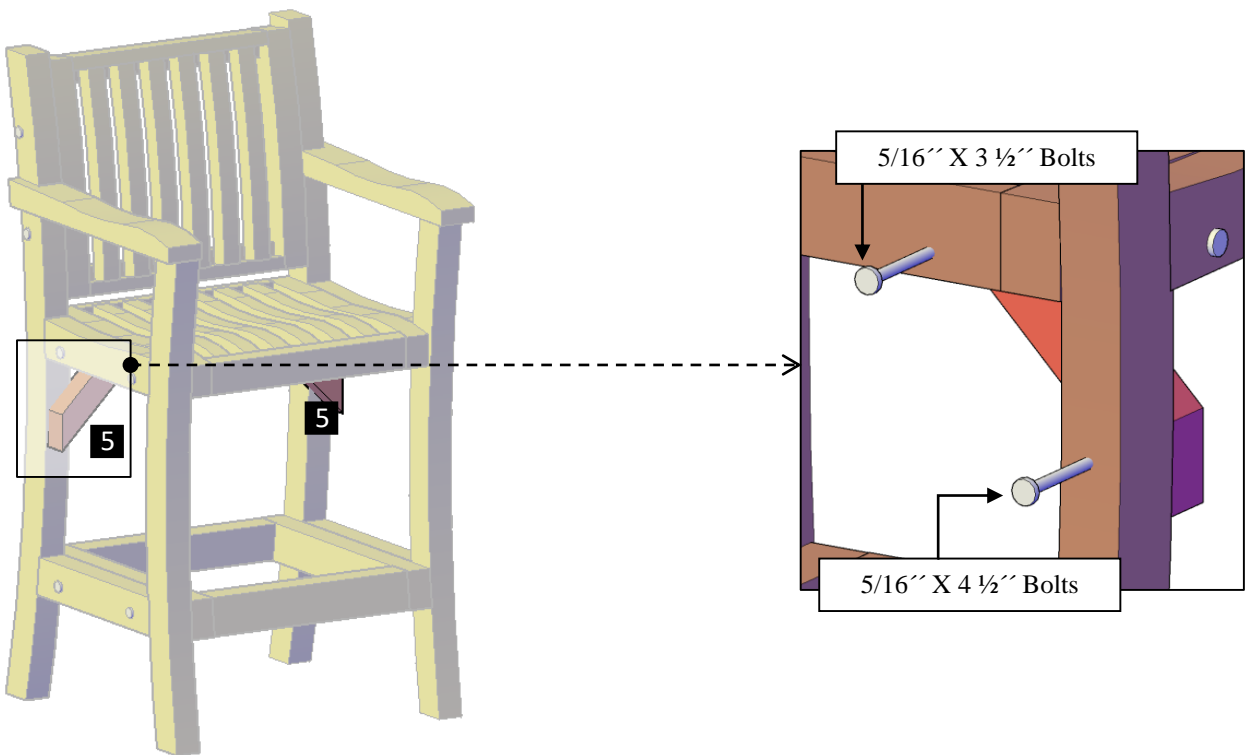

Redwood Cocktail Bar Stool – With Arms

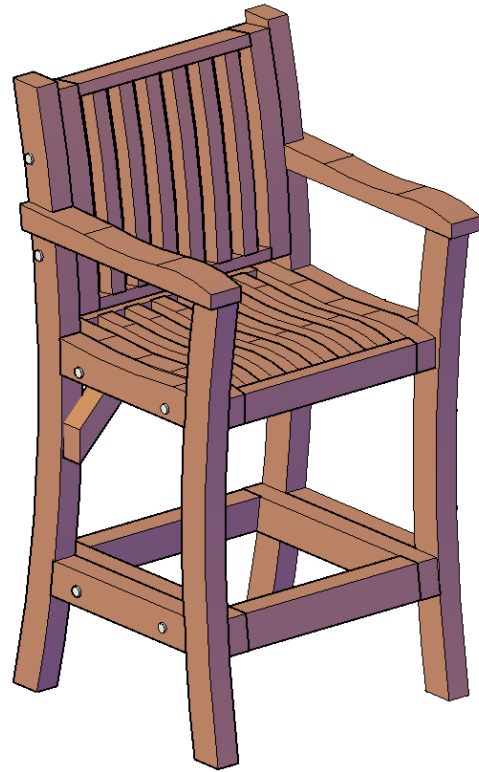

Redwood Cocktail Bar Stool – Armless





This completes the Bar Stool assembly. Hope you enjoy your set for many decades. If you ever have a problem or a question, don't hesitate to call us (866 332 2403) or email us. We are here to support you.