



Old-Growth Again
Restoring Logged Forests
One Tree At A Time



ASSEMBLY INSTRUCTIONS FOR:

360 GAZEBO



Old-Growth Again
 Restoring Logged Forests
 One Tree At A Time



360 GAZEBO

Quantity	Description	Drawing
4	Front wall panels – door and window panels	
5	Rear wall window panels	
24	Wall Posts	
10	Left side & right side walls	
2	Doors	

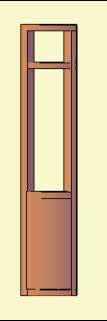
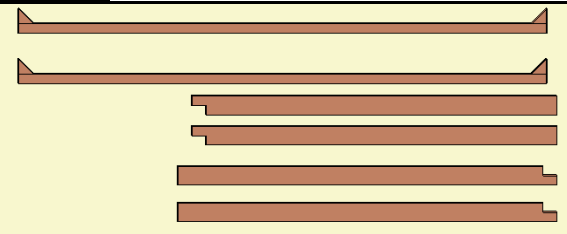
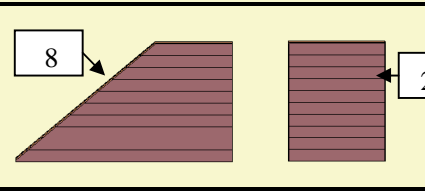
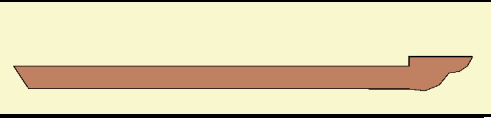
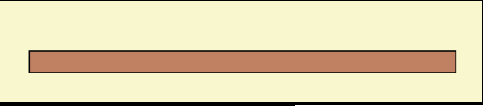
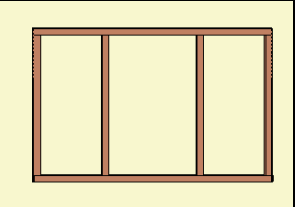
4	Angled Corner Panels	
6	Roof timbers	
10	Roof panels	
10	Rafters	
10	Roof trim	
1	Skylight	

Quantity	Description
6	Bolts 4" x 5/16", washers & nuts
10	Bolts 6 1/2" x 3/8", washers & nuts
4	Bolts 3 1/2" x 5/16", washers & nuts
8	Bolts 4 1/2" x 5/16", washers & nuts
4	Bolts 8" x 3/8", washers & nuts
100	Screws 3"x 8" SS

ASSEMBLY INSTRUCTIONS

The parts that go together have the same numbers written next to the predrilled holes they attach to. Align the parts with the numbers as shown for ease of reference.

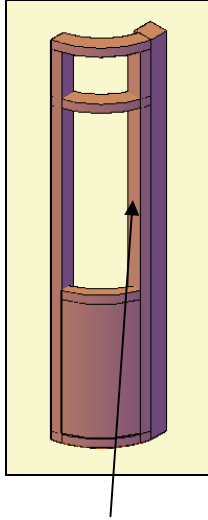

Step 1:
Attach corner panel to post with six deck screws (3"X 8"). (Match up the numbers to attach the two parts together).

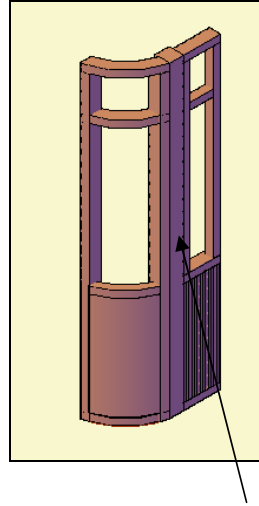

Step 2:
Attach front wall panel to post with six deck screws (3"X 8"). (Match up the numbers to attach the two parts together). And repeat the steps 1 & 2 in all walls & the post.

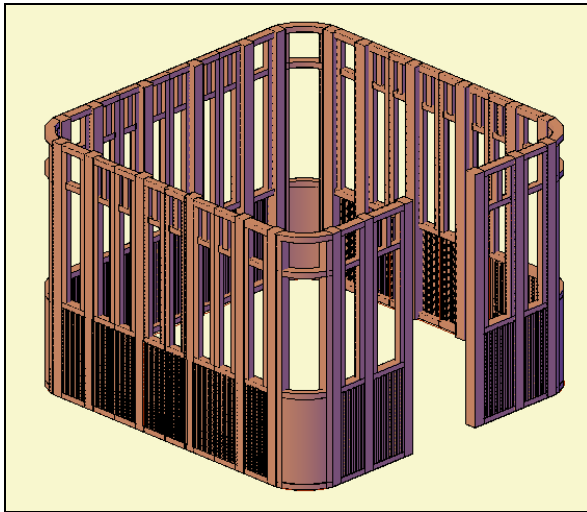

When you finish the walls of the Gazebo should be as shown.

Step 3:

Attach the timbers together to form the base of the roof with 4 bolts (3 1/2"x 5/16") washers & nuts. (Match up the numbers to attach the two parts together). Tap the bolt all the way into the wood to set it. Then add a washer and nut and lightly tighten.

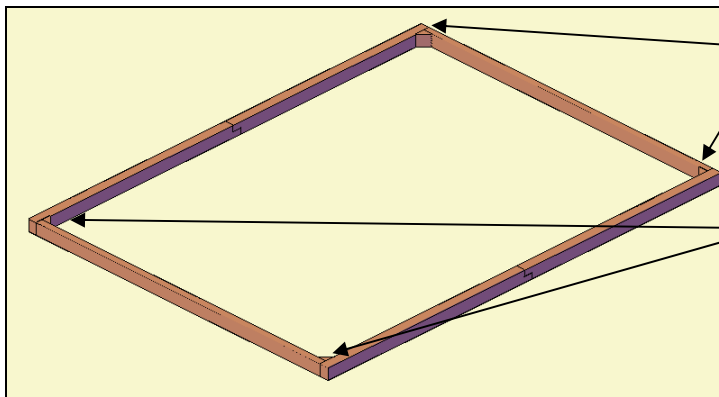
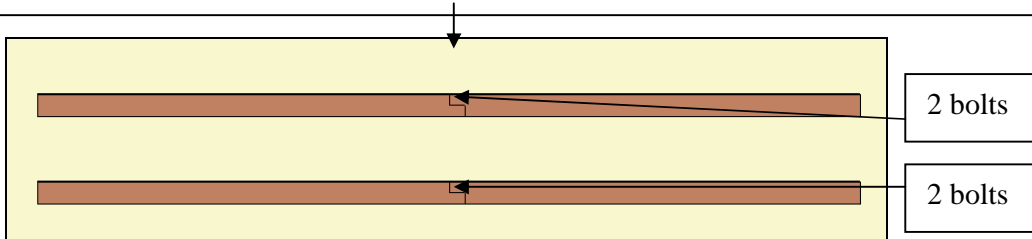

Step 4:

Attach the rest of the base of the roof with 8 bolts (4 1/2"x 5/16") washers & nuts. Take the timbers from step 3 and add the other roof timbers as shown. (Match up the numbers to attach the two parts together). Tap the bolt all the way into the wood to set it. Then add a washer and nut and lightly tighten.

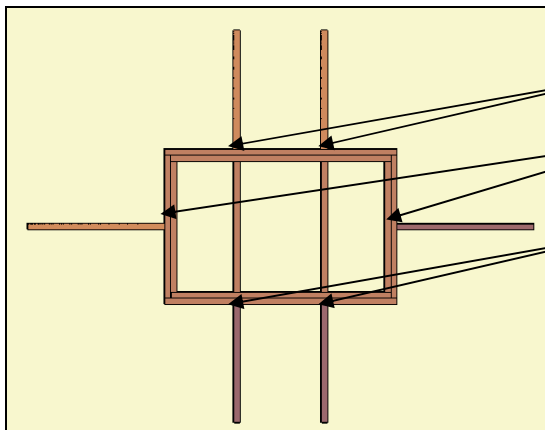

Step 5:

Attach the center rafters to the skylight with 6 bolts (4"x 5/16") washers & nuts. (Match up the numbers to attach the two parts together). Tap the bolt all the way into the wood to set it. Then add a washer and nut and lightly tighten.

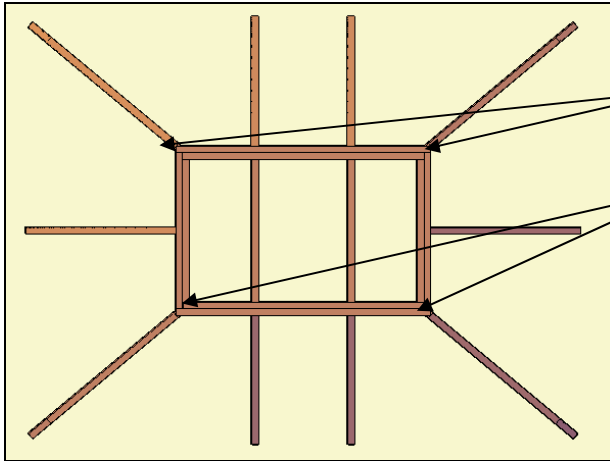

Step 6:

Attach the corner rafters to skylight with 4 bolts (8" x 3/8") washers & nuts. (Match up the numbers to attach the two parts together). Tap the bolt all the way into the wood to set it. Then add a washer and nut and lightly tighten.

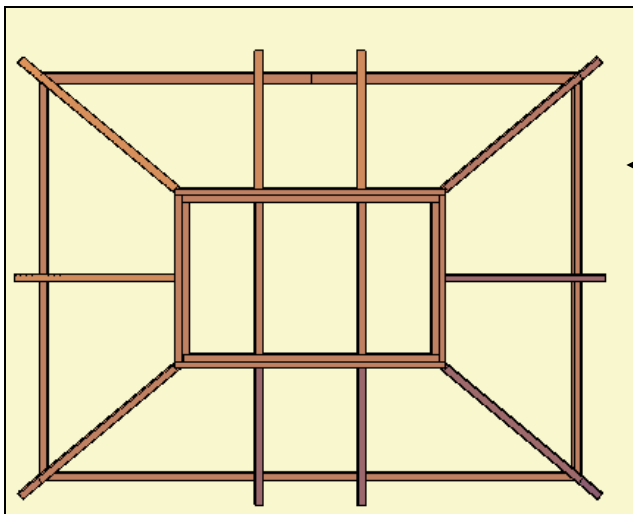

Step 7:

Attach the rafters to base of the roof with 10 bolts (6 1/2" x 3/8") washers & nuts. (Match up the numbers to attach the two parts together). Tap the bolt all the way into the wood to set it. Then add a washer and nut and lightly tighten.

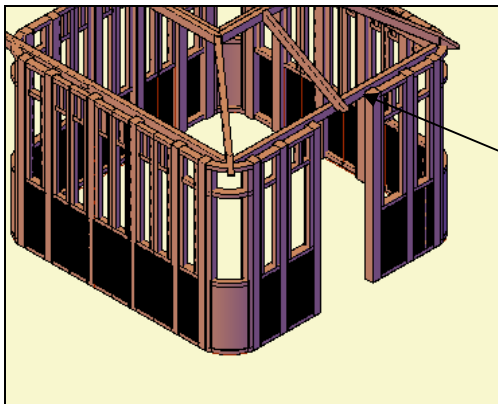

Step 8:

Attach the roof to the top of the Walls with 30 deck screws (3" x 8") – approximately 3 per panel. (Match up the numbers to attach the two parts together).

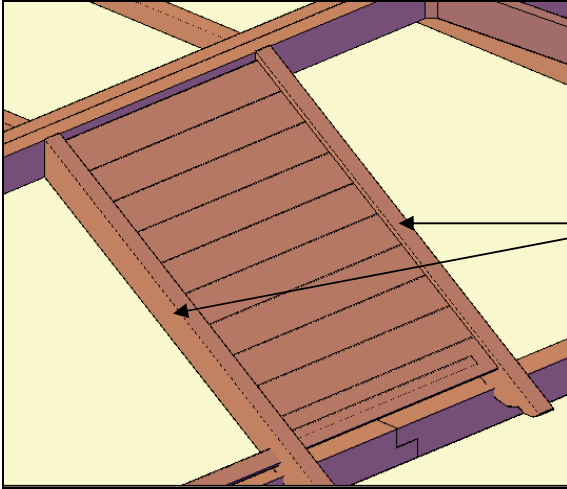

Step 9:

Attach the Roof panel to the rafters with six deckscrews (3" x 8"). And repeat the process with each panel roof panel.

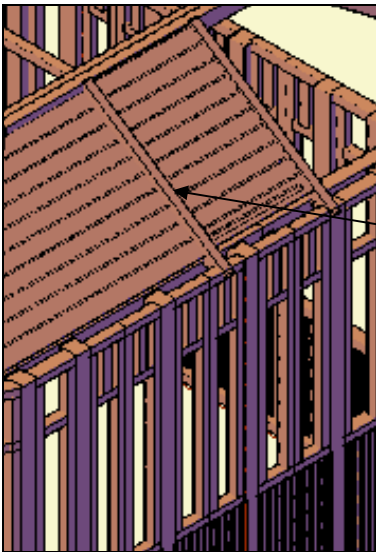

Step 10:

Attach the roof trim between each roof panel with three deckscrews (3" x 8"). And repeat the process for each space between the installed roof panels.

Step 11:

Attach the doors to the metal hardware installed in the door panels. Use deckscrews (3" x 8").