

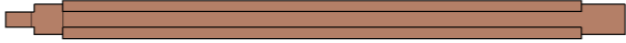









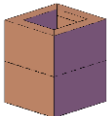

866.332.2403 (Toll Free); 8am-5pm Pacific Time, Monday-Friday

Assembly instructions for: **MARIN OUTDOOR KITCHEN PERGOLAS**



CONTENT OF BOXES

QUANTITY	DESCRIPTION	DRAWING	
4	Posts		
4	Dual Support Beams (usually ship in 2 parts that include blocking timber(s) attached to one of the 2 dual supports)		
Quantity will vary depending on size	Arched Rafters		
Quantity will vary depending on size (if you ordered)	Roof Slats		
4	Secondary Knee Braces (strengthens union between posts and rafters)		
4	Main Knee Braces (strengthen union between posts and dual support timbers)		
4	Trim pieces for bottom of posts		
Depending on size	Hardware: Bolts and deck screws	Deck Screws	Bolts, washers and nuts
			
2 (if you ordered)	Anchors (U brackets, Gale Wind or hurricane anchors)	Hurricane anchors	
		U brackets	Gale Wind
			
			
1 (if chosen)	Ceiling Fan base		

ASSEMBLY INSTRUCTIONS

All Pavilions are completely erected in the shop prior to crating for shipping. All hardware is included. All parts are fully sanded, routed, notched, drilled and numbered for ease of reassembly. The parts that go together have the same numbers/letters written next to the predrilled holes they attach to.

All Pavilions parts are notched into the part they connect to. You'll find the numbers next to the notches and/or drill holes. Before beginning re-assembly, place the parts that go together on the ground with one another so you don't have to be searching around in the middle of the reassembly. Most pavilions take less than one day to reassemble with one helper. Very large pergolas (6 posts or larger) usually require a second day to finish up.

Note: print the drawings that you approved before start the construction, they are needed to see the distances between the posts.

Step 1. Attach the post to the ground. There are different ways to do it. Please see the **How to anchor your pergola document**.

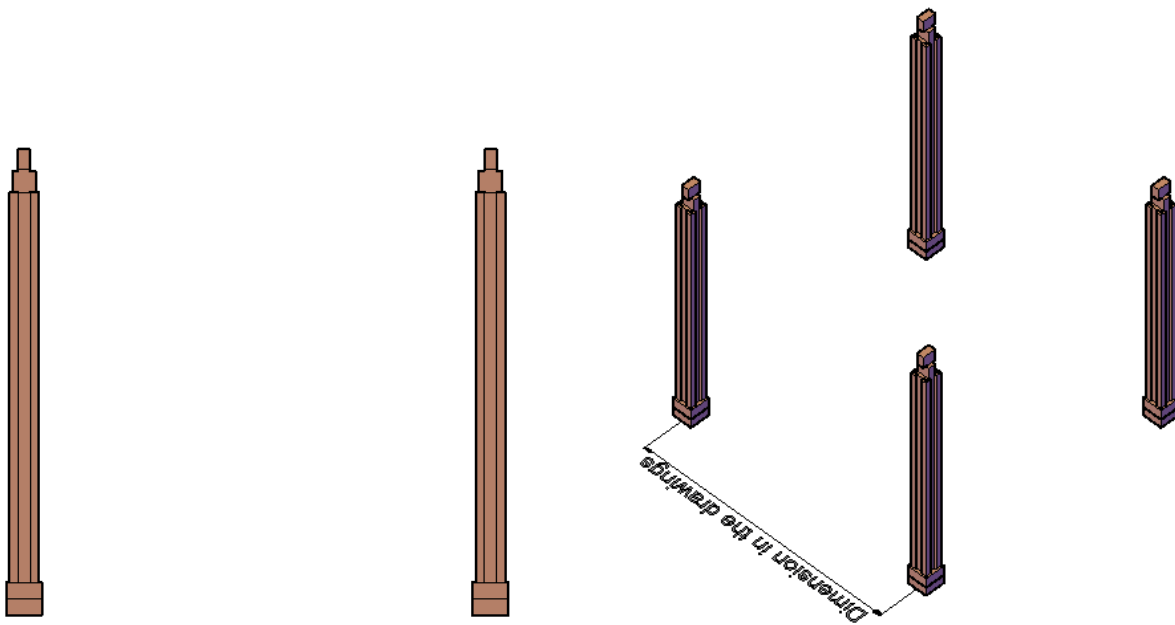

Step 2. Attach dual support beams to posts with four bolts (6" x 3/8") washers & nuts. (Match numbers). Tap the bolt all the way into the wood to set it, then add a washer and nut and lightly tighten.

Repeat this step with the other dual support beams.

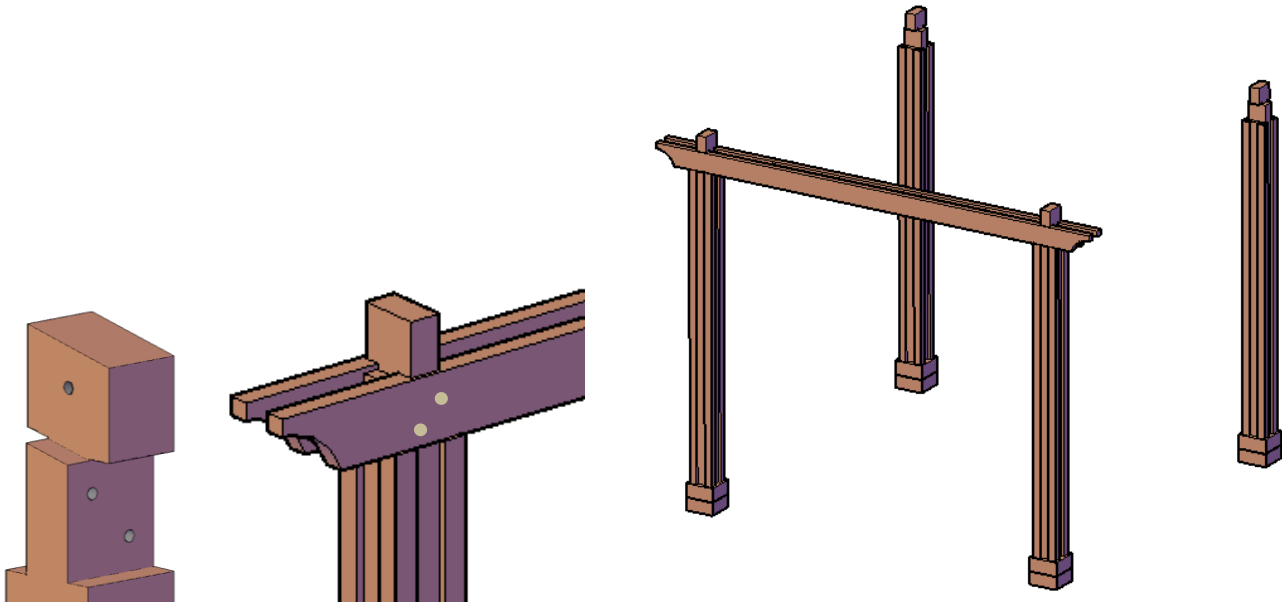

One the 2 supports have one large beam already attached or a few 18" pieces depending on size, this add support and strength to the structure. This beam must be in the interior of the support and bolted after you attach the supports to posts as shown below:

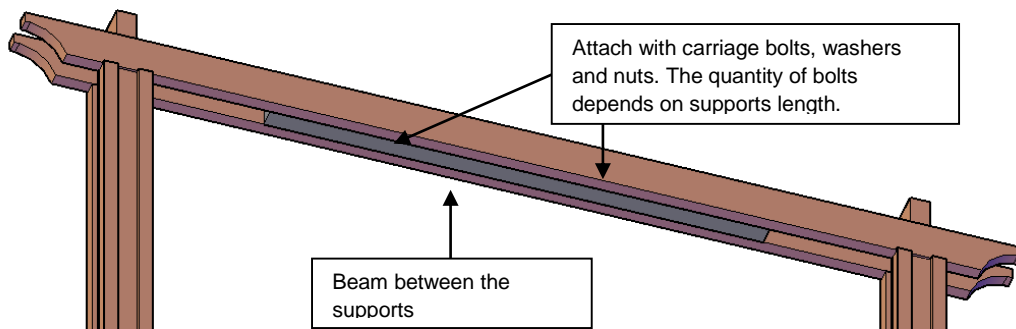

Step 3. Attach corner arched rafter to posts with one bolt per post (6 " x 3/8") washers & nuts. (Match numbers). Tap the bolt all the way into the wood to set it, then add a washer and nut and lightly tighten.

Repeat this step in the other side (Rafter and Posts).

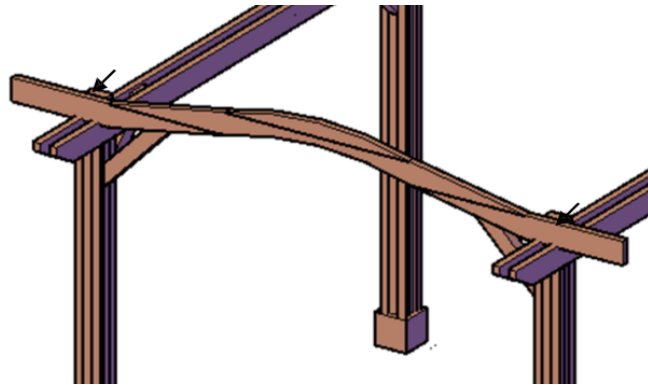

Step 4. Attach secondary knee brace to post & arched rafter with two bolts, washers & nuts. (Match numbers). Tap the bolt all the way into the wood to set it, then add a washer and nut and lightly tighten. *Repeat this step with the other end arched rafter,*

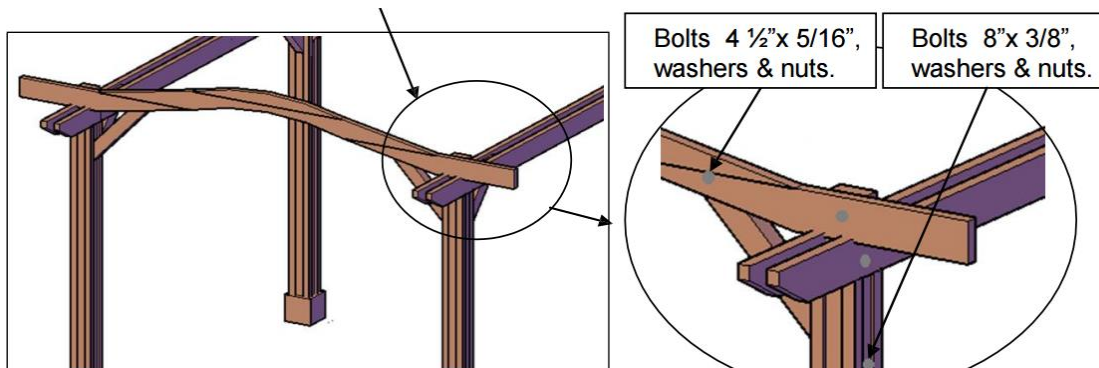

Step 5. Attach main knee brace to post & dual support beams with two bolts, washers & nuts. (Match numbers). Tap the bolt all the way into the wood to set it, then add a washer and nut and lightly tighten. *Repeat this step with the other main knee brace.*

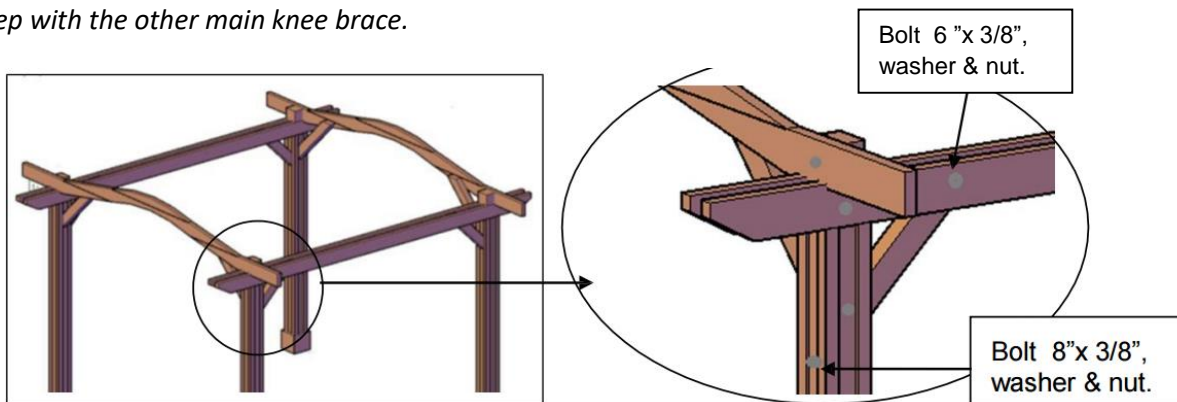

Step 6. Attach supports to supports with galvanized deck screws (3"x #8") at 45 degree angles to attach to the supports. There are 8 screws used per slat (2 per support). Make sure each rafter's notches are snugly into the supports before adding the deck screws. The supports have lines marking the exact spot to attach the rafter. The interior rafters do not have numbers. They are all cut identically and are interchangeable. Just make sure to stay to the markings on the supports to keep the spacing exactly the same (default rafter spacing is 18" on center unless custom ordered differently). Start at one end and attach one rafter at a time from both sides and on both ends before moving to the next rafter. *And repeat the process in all roof Rafters.*

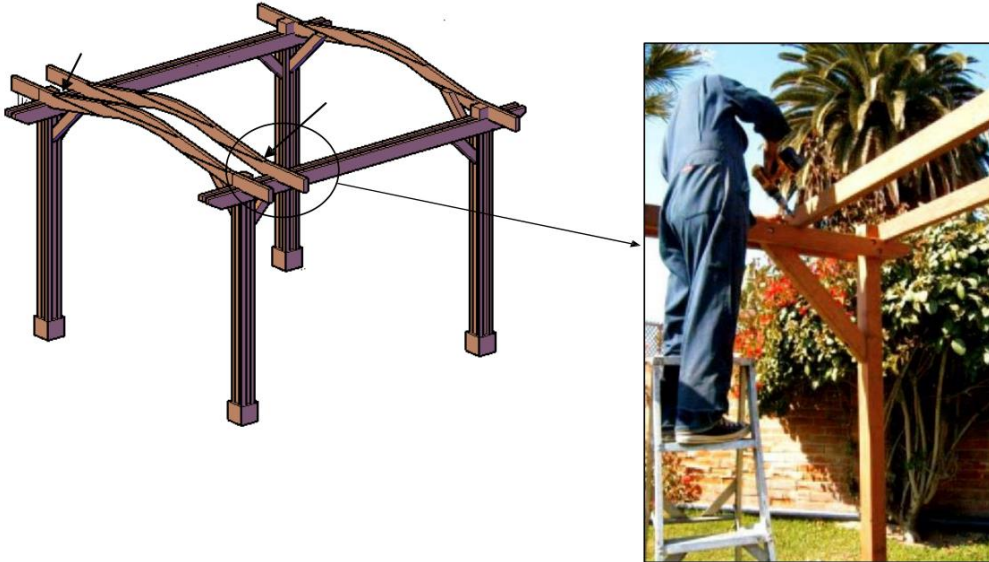

Step 7: Attach roof slats to rafters & with deck screws (3"x #8"). The roof slats are all notched identically. The roof slats are notched to fit into each of your rafters. The rafter tops are marked in ink every 18 inches with 2 lines. Place one roof slat into the lines on one end and begin to attach. *And repeat the process in all roof slats*

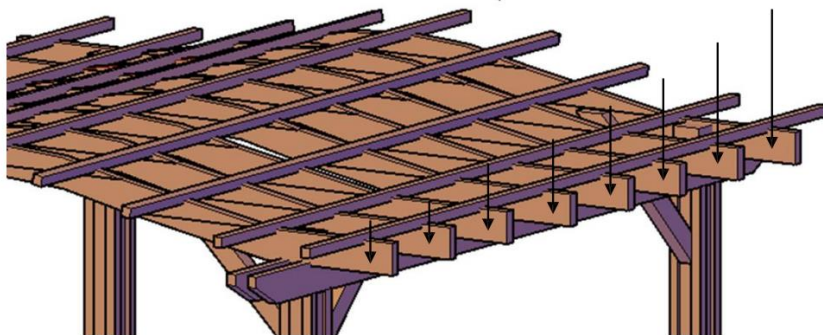

This completes the pavilion assembly. Hope you enjoy your set for many decades. If you ever have a problem or a question, don't hesitate to call us (866 332 2403) or email us. We are here to support you.