

---

866.332.2403; Outside the US: 619.600.5630 7am-7pm Pacific Time, Monday-Saturday





## Assembly Instructions for: **RECLINING EASYCHAIRS**

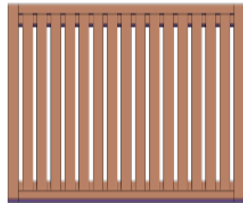
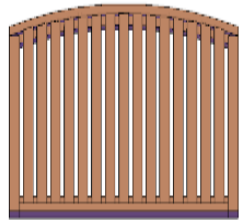
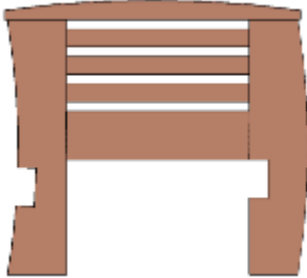

Thank you for purchasing Forever Redwood patio furniture. Forever Redwood is built by Old-Growth Again Restoration Forestry (OGA). OGA is dedicated to restoration forestry. Sales of patio furniture finance our restoration work in California redwood forestlands.

**Tools required:** ½-inch ratchet and a mallet or small hammer.

**Box Content:**

Quantity	Description	Drawings
1	Seat	
1	Backrest	
2	Sides	
2	Diagonal Supports	
1	Front Support	
1	Rear Support	
6	3 ½" x 5/16" Bolts	
8	4 ½" x 5/16" Bolts	
2	Nylon Nuts	

Your furniture was fully assembled in the shop prior to being dismantled for shipping. All the parts fit. The parts that go together have the same numbers written next to the predrilled holes they attach to. Please take the time to align the parts with the numbers. If you are forcing a bolt in, the part may be turned around or not aligned properly. Tap the bolt all the way into the wood to set it, then add a washer and lightly tighten. Don't over tighten or you will crush the redwood.

**Step 1:** Unpack your Easychair and make sure you have all the parts. Attach Seat to backrest. Take the back rest and attach it to the seat as shown in the photo C below. Use the long carriage bolts (4 1/2") as shown in the photo D below. Add a washer and use the nylon threaded nuts provided to insure the nut doesn't come loose over the years. Don't overtighten.

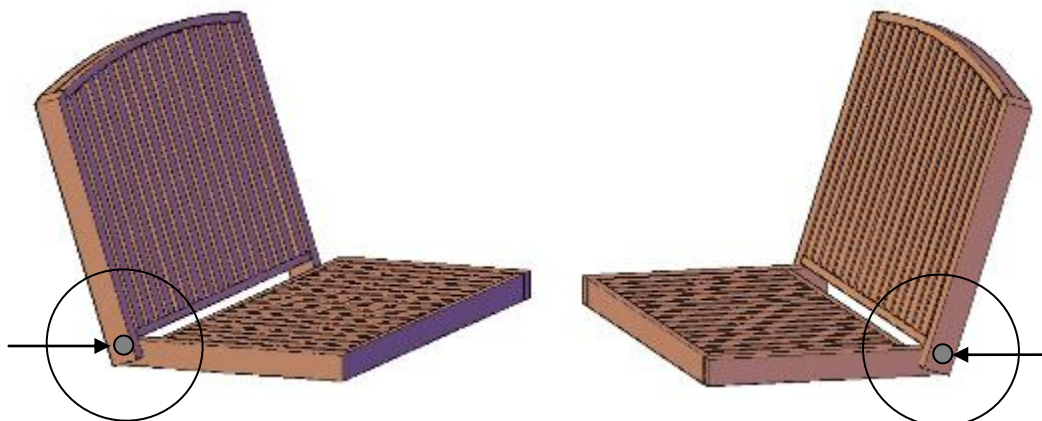

**Step 2:** Attach sides to backrest & seat. Each side has a groove on the inside of the frame for both the seat and the backrest to independently slide within. Each side has numbers written next to the grooves. On the sides of the seat/back rest you'll find predrilled holes, one on each side of the chair and two on each side of the backrest. Next to these holes are numbers. Match the numbers to the numbers on the inside frames of the chair sides where the grooves are. Tap two of the 3 1/2" carriage bolts into each side of the back rest from the inside out. Make sure to tap them all the way into the wood to set them so they won't spin when you tighten them later. Don't over tighten or you'll crush the wood and weaken your set's structural strength.

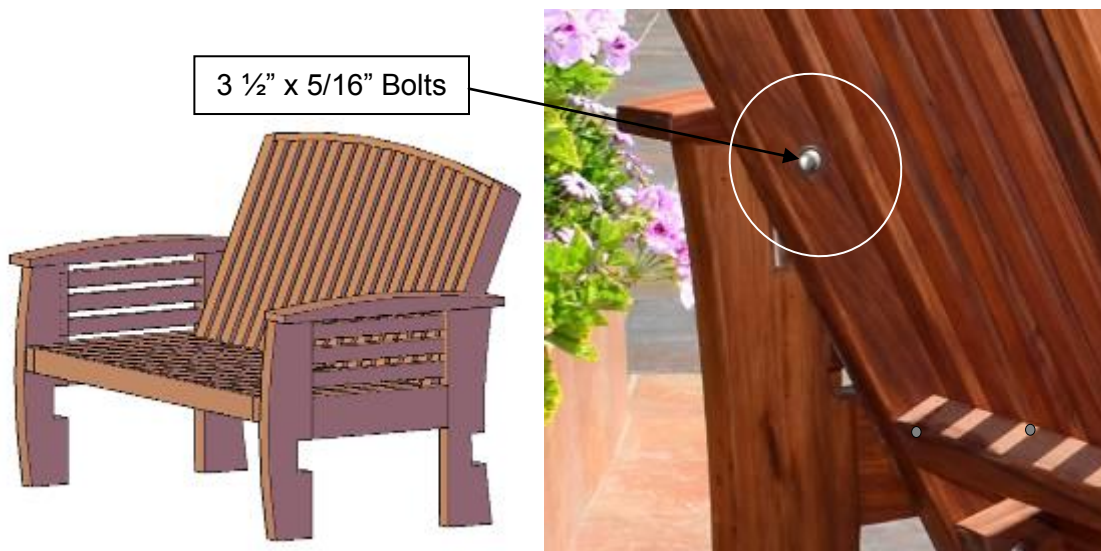



**Step 3:** Attach front support to sides with 2 bolts (4 1/2" x 5/16" Bolts) per side as shown below. Match the numbers next to the predrilled holes on the side's notch to the numbers on the back front support on each chair side. Tap the carriage bolts all the way into the wood, then attach the washers, nuts and tighten with 1/2-inch ratchet. Do not over-tighten. Repeat this step to attach rear support.

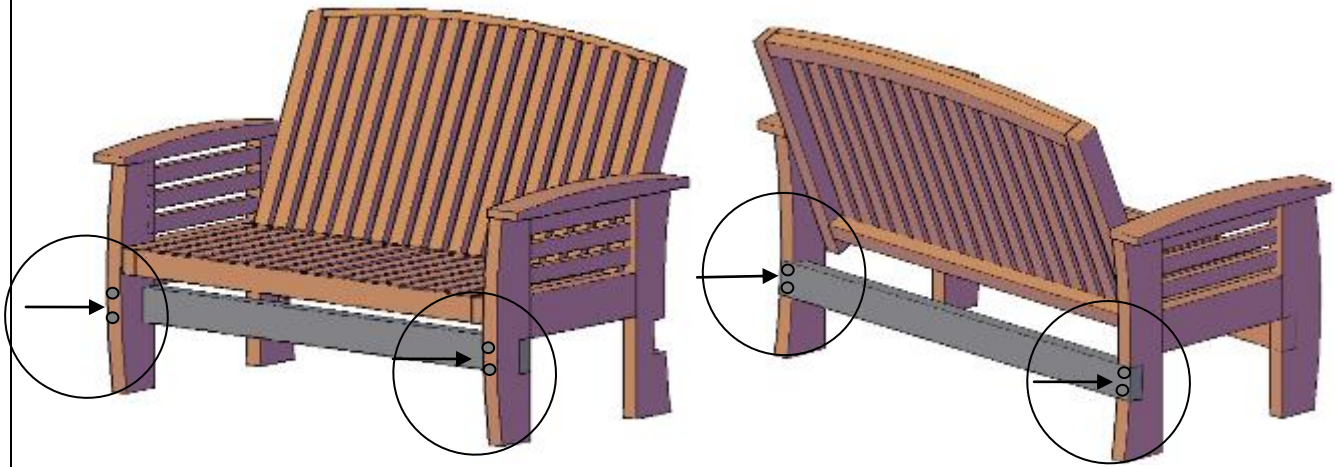

**Step 4:** Attach diagonal support to side and rear support with 2 bolts (3 1/2" x 5/16" Bolts), washers and nuts. Match the numbers next to the predrilled holes on the interior of the sides to the numbers on the rear support. Tap the carriage bolts all the way into the wood, then attach the washers, nuts and tighten with 1/2-inch ratchet. Do not over-tighten. Repeat this step for the other diagonal support.



Thank you! If you have any questions, please call or email us.