



FOREVER REDWOOD

From the Forest, For the Forest since 1995



866.332.2403 (TOLL FREE); 7am – 7pm Pacific Time, Monday-Saturday

ASSEMBLY INSTRUCTIONS FOR THE **ADIRONDACK SIDE TABLE**





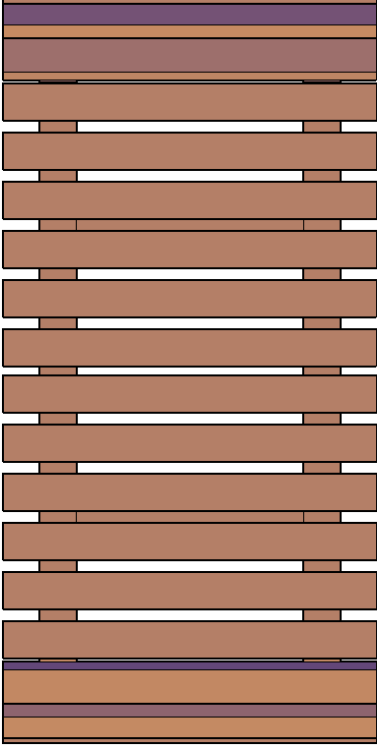

CONTENT OF BOXES

Qty.	Description	Drawing	No.
1	Seat		1
4	Legs		2

Note: Part numbers in the Content of Boxes Table are for reference only. These do not match to the numbers marked on the parts sent.

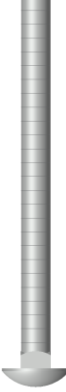

HARDWARE

Qty.	Description	Drawing	No.
8	5/16" X 3 1/2" Bolts (To attach the legs to the tabletop).		A
8	3/8" X 7/8" Washers		B
8	5/16" Nuts		C

Note: Dimensions of your hardware will vary depending on size.



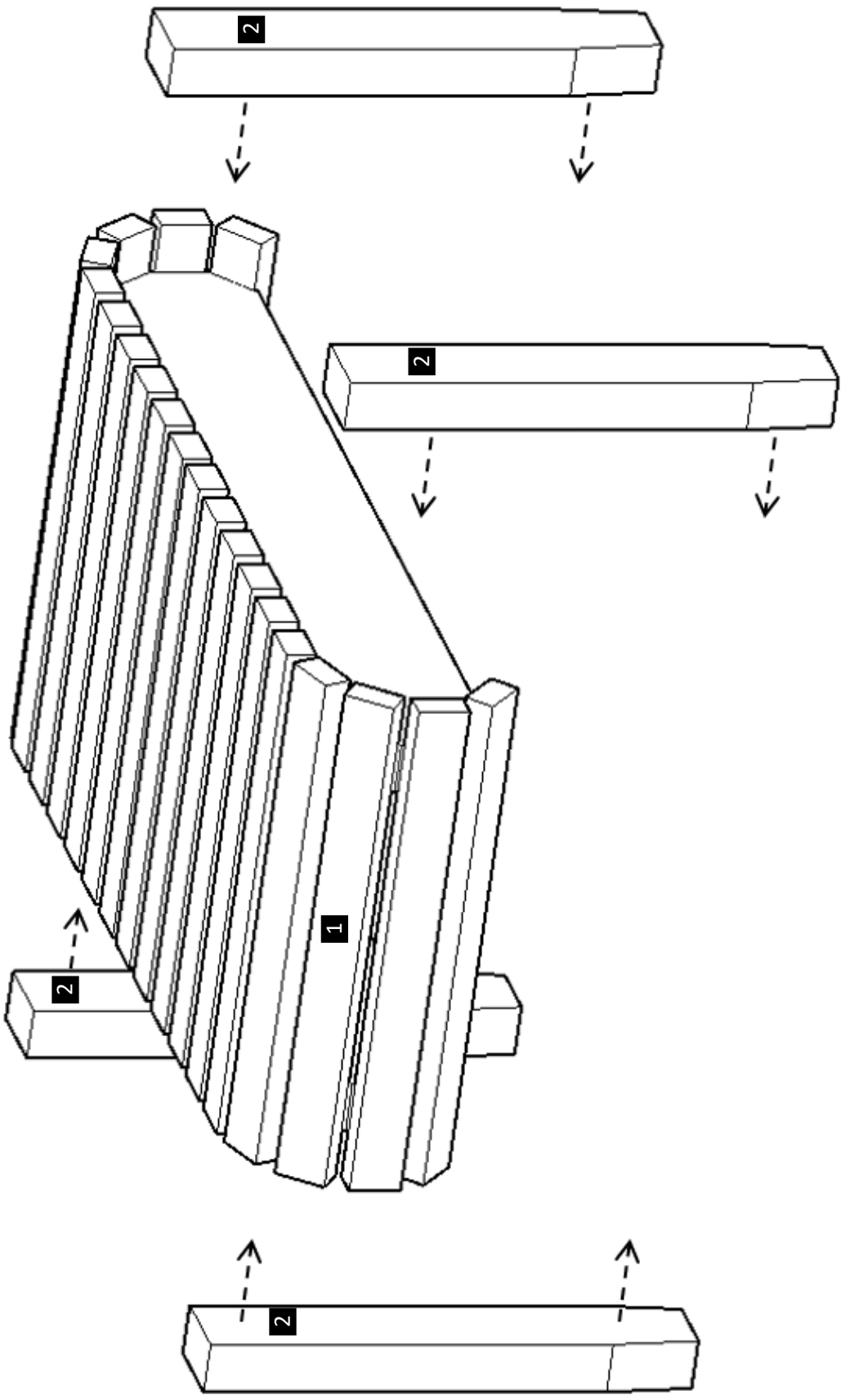

DESCRIPTION	No
Seat	1
Legs	2

Note: Part numbers in the Drawing are for reference only. These do not match to the numbers marked on the parts sent.

Step 1: Place the Tabletop (1) upside down. After that, use 5/16" x 3 1/2" bolts (A) with washers and nuts to attach the legs (2) to the tabletop. Each part has a series of numbers that indicate where to attach the part with the corresponding number.

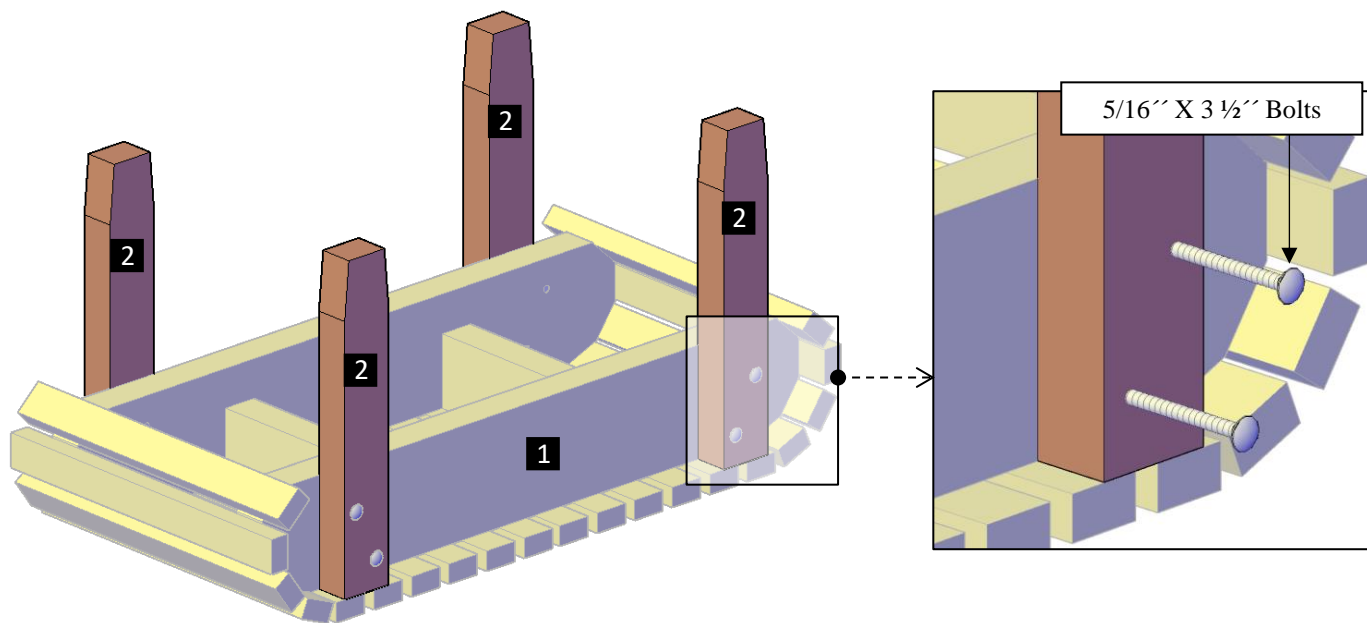

Step 2: Finally, turn the table over its feet.

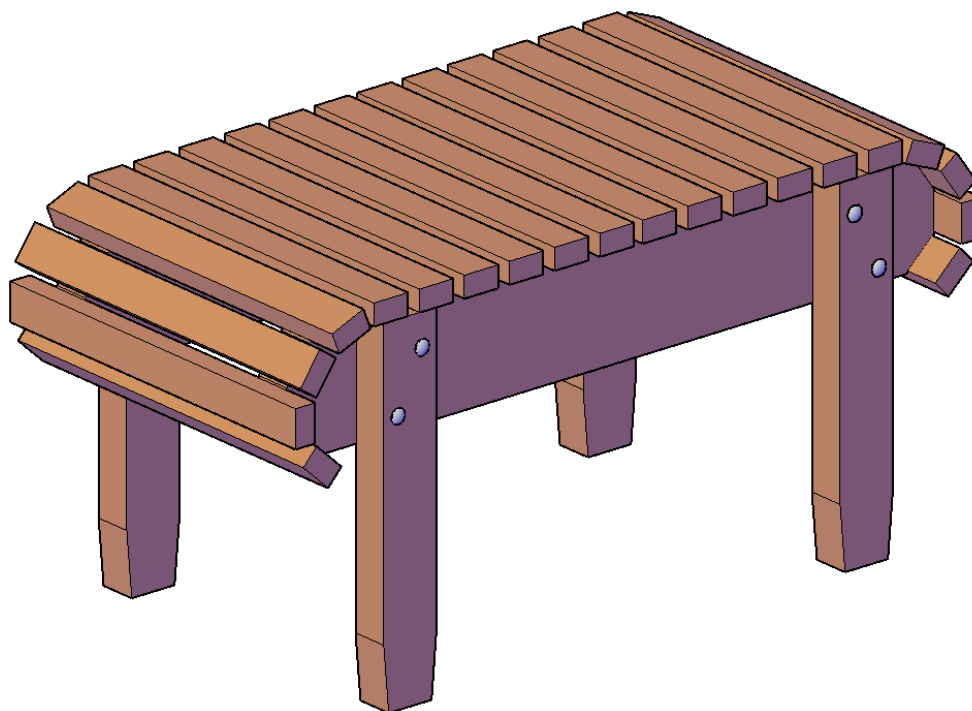



This completes the Table assembly. Hope you enjoy your set for many decades. If you ever have a problem or a question, don't hesitate to call us (866 332 2403) or email us. We are here to support you.