



FOREVER REDWOOD

From the Forest, For the Forest since 1995

866.332.2403 (TOLL FREE); 7am – 7pm Pacific Time, Monday-Saturday

ASSEMBLY INSTRUCTIONS FOR THE **ENSENADA WOODEN ROCKING CHAIR**





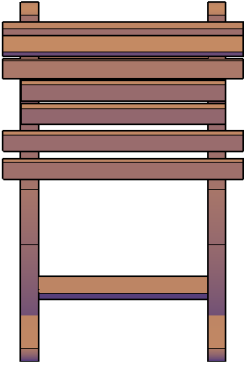
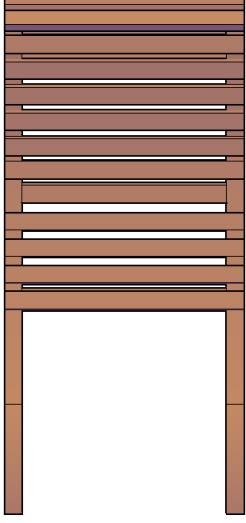
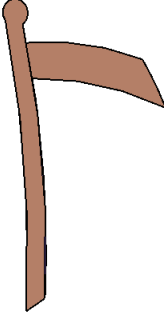

CONTENT OF BOXES

Qty.	Description	Drawing	No.
1	Seat		1
1	Backrest		2
2	Armrests		3

Note: Part numbers in the Content of Boxes Table are for reference only. These do not match to the numbers marked on the parts sent.

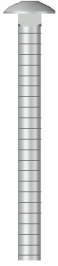
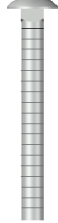

HARDWARE LIST

Description	Drawing	No.
5/16" X 3 1/2" Bolts (To attach the backrest and the armrests to the seat).		A
5/16" X 3" Bolts (To attach the armrests to the backrest).		B
5/16" Washers		C
5/16" Nuts		D

Note: Dimensions of your hardware will vary depending on size.



DESCRIPTION	No
Seat	1
Backrest	2
Armrests	3

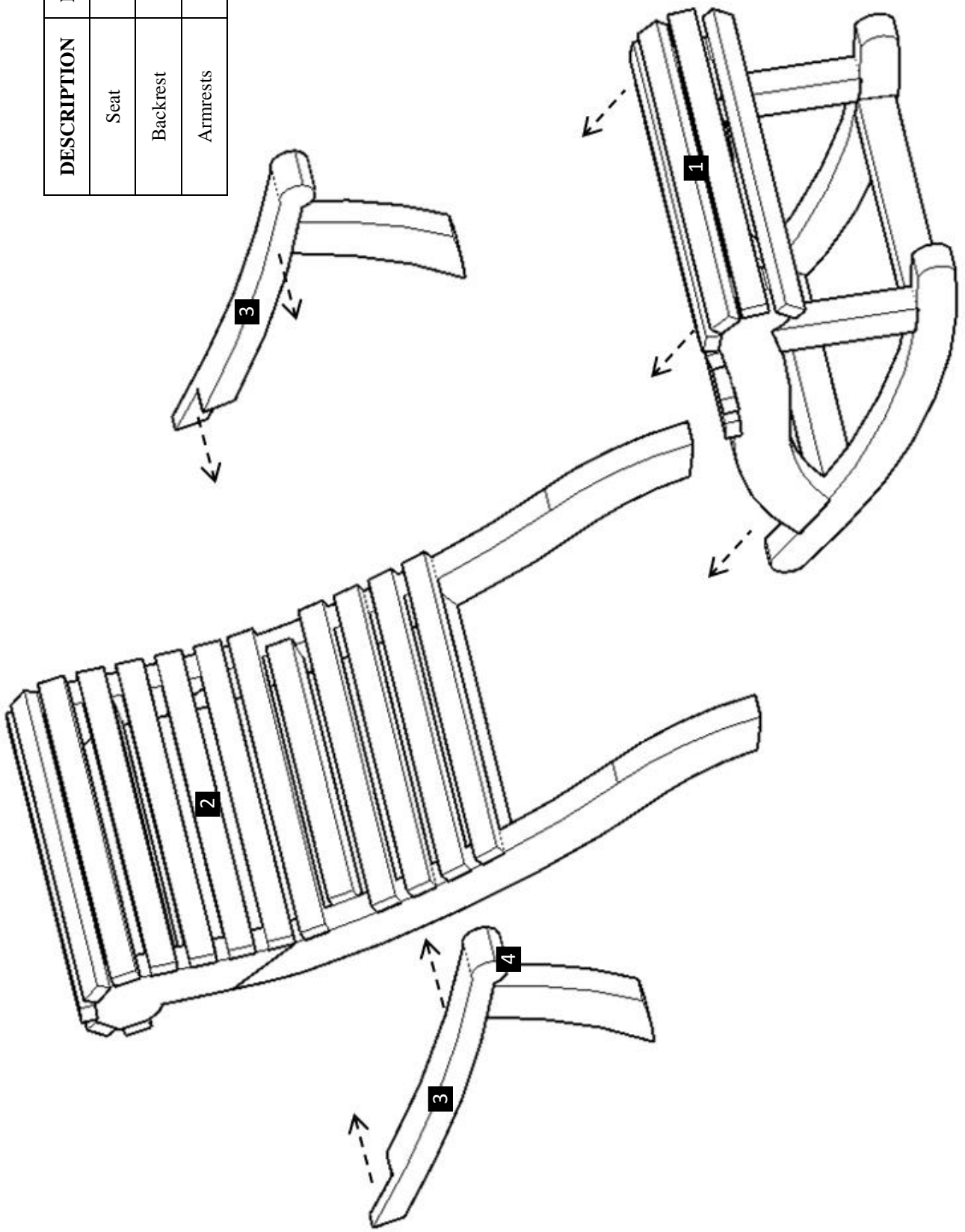

Note: Part numbers in the Drawing are for reference only. These do not match to the numbers marked on the parts sent.

Step 1: Use 5/16" x 3 1/2" bolts (A) with washers (C) & nuts (D) to attach the backrest (2) to the seat (1). Each part has a series of numbers that indicate where to attach the part with the corresponding number.

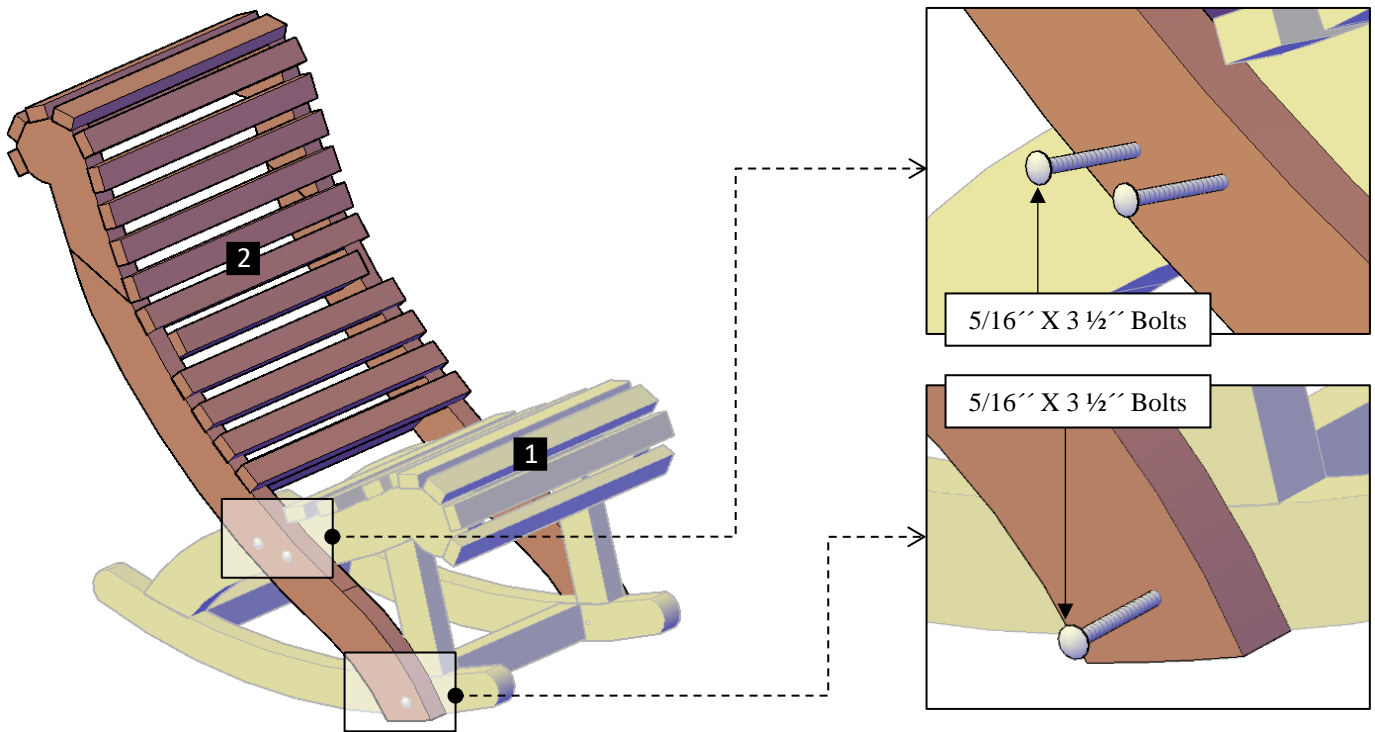

Step 2: Finally, attach the armrest (3) to the backrest with 5/16" x 3" bolts (B), washers (C) & nuts (D). After that, use 5/16" x 3 1/2" bolts (A) with washers (C) & nuts (D) to attach the armrest to the seat. Each part has a series of numbers that indicate where to attach the part with the corresponding number.

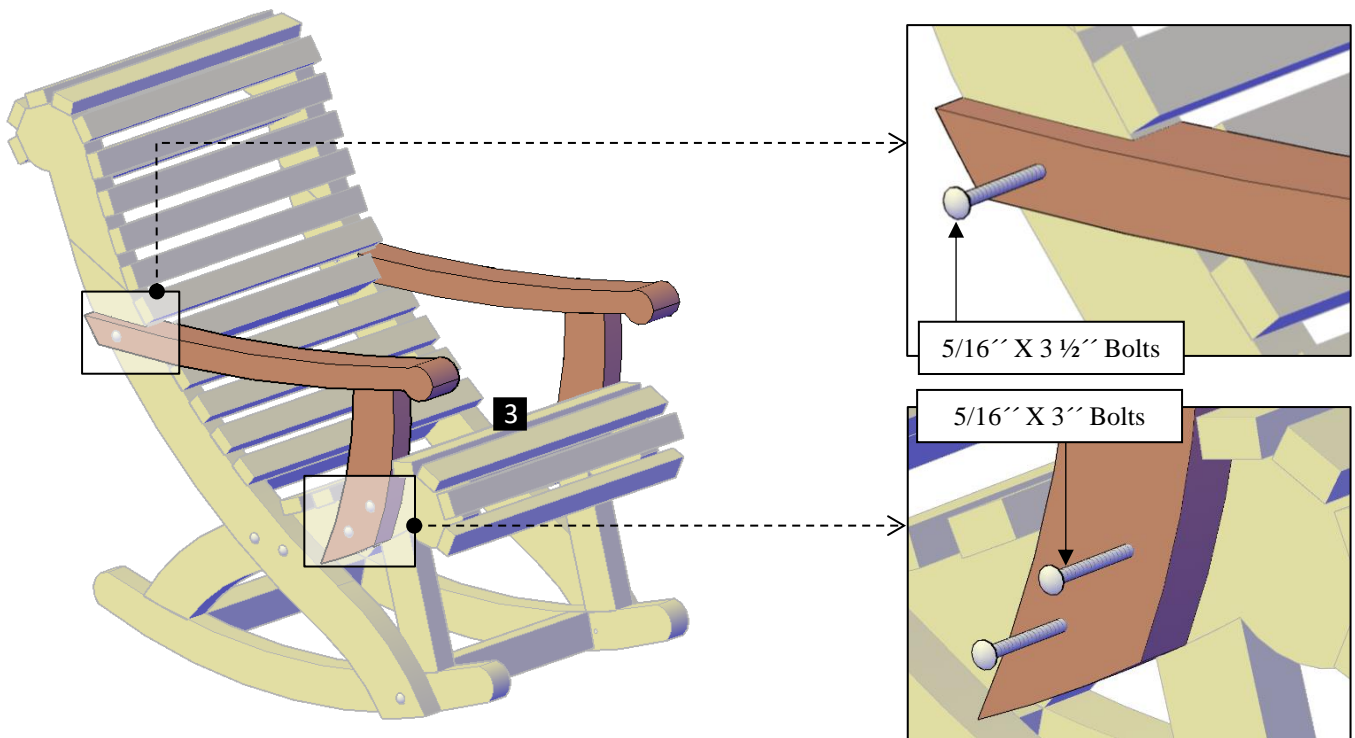



This completes the Picnic Table assembly. Hope you enjoy your set for many decades. If you ever have a problem or a question, don't hesitate to call us (866 332 2403) or email us. We are here to support you.