



FOREVER REDWOOD



From the Forest, For the Forest since 1995

866.332.2403 (TOLL FREE) (707) 640.29.05 (Option 4) Direct Line for the Design Department; 7am – 7pm Pacific Time, Monday-Saturday

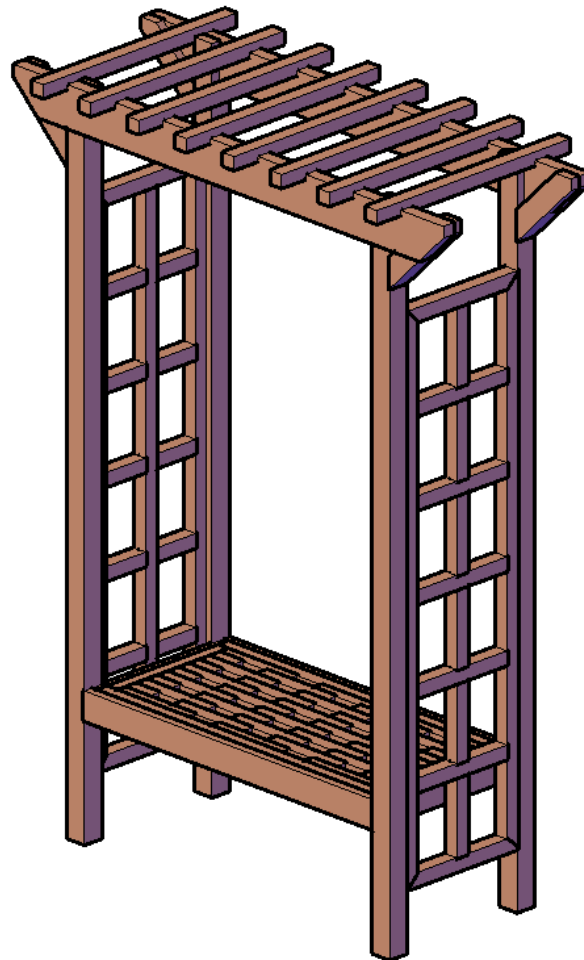
ASSEMBLY INSTRUCTIONS FOR THE GARDEN ARBOR BENCH



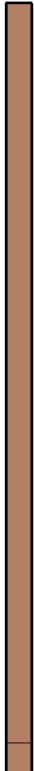
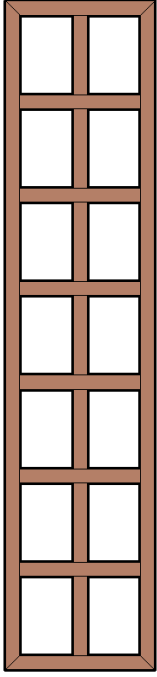
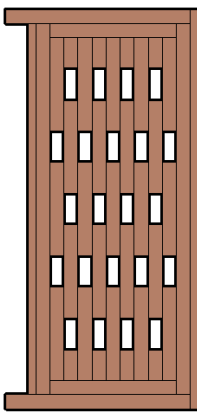

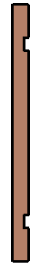

CONTENT OF BOXES			
Qty.	Description	Drawing	No.
4	Posts		1
2	Lateral Trellis Walls		2
1	Seat		3
2	Supports		4
4	Knee Braces		5
8	Slats		6

Note: Part numbers in the Content of Boxes Table are for reference only. These do not match to the numbers marked on the parts sent.

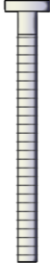
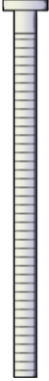
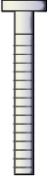
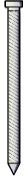
HARDWARE LIST

Qty.	Description	Drawing	No.
16	5/16" X 4 1/2" Bolts (To attach the trellis walls to the posts. / To attach the seat to the posts. / To attach the knee braces to the posts).		A
4	3/8" X 5 1/2" bolts (To attach the seat to the posts).		B
12	5/16" X 2 3/4" bolts (To attach the knee braces to the support).		C
20	3" Deck Screws (To attach the slats to the supports).		D
32	Washer		E
32	Nuts		F

Note: Dimensions of your hardware will vary depending on size.

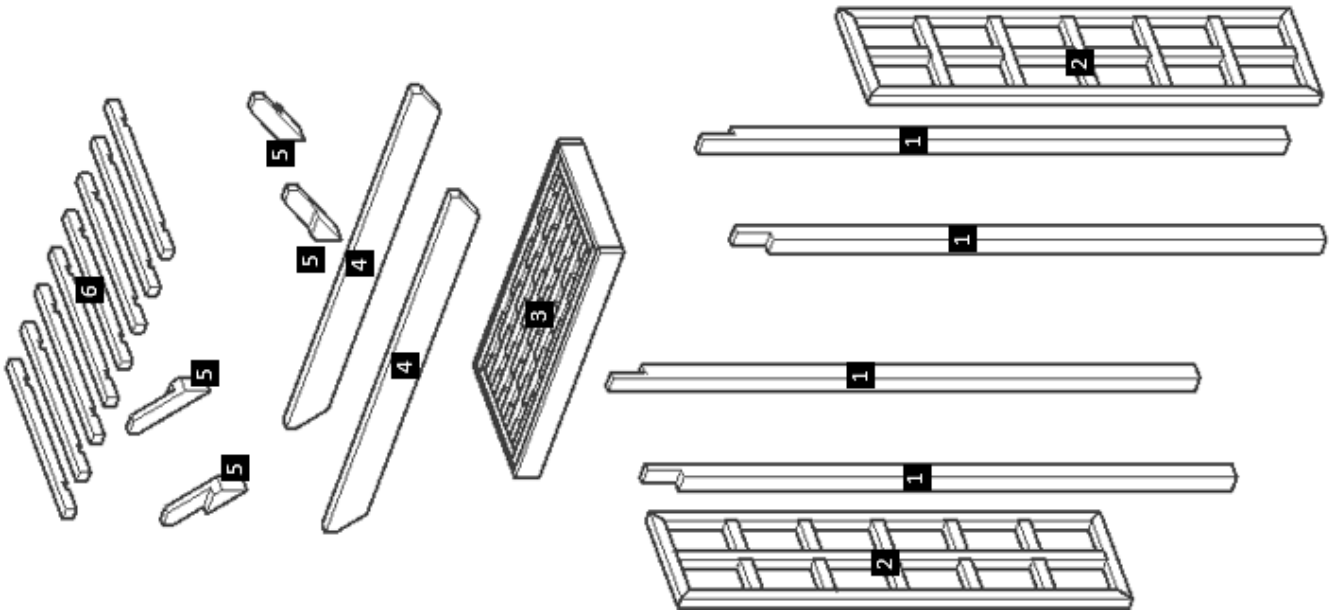

DESCRIPTION	No.
Posts	1
Lateral Trellis Walls	2
Seat	3
Supports	4
Knee Braces	5
Slats	6

Note: Part numbers in the Drawing are for reference only. These do not match to the numbers marked on the parts sent.

Step 1: Attach the lateral trellis walls (2) to the posts (1) with 5/16" X 4 1/2" bolts (A) with washer and nuts. Each part has a series of numbers that indicate where to attach the part with the corresponding number.

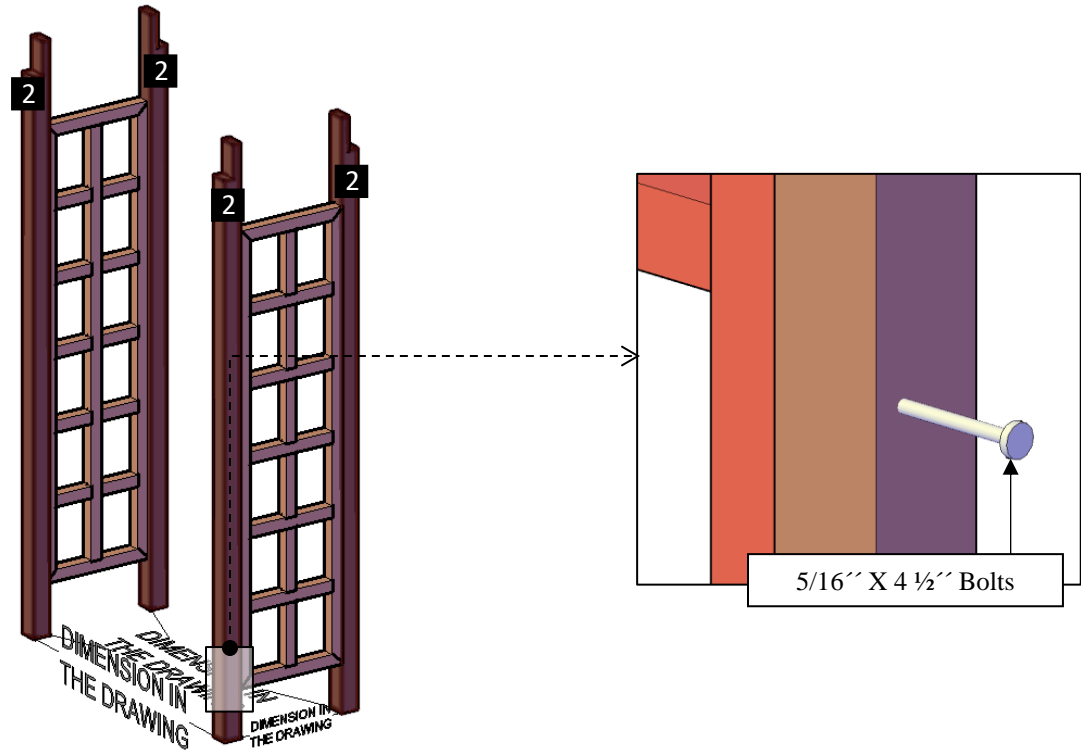

Step 2: Attach the seat (3) to the posts with 3/8" X 5 1/2" bolts (B) with washer and nuts. Each part has a series of numbers that indicate where to attach the part with the corresponding number.

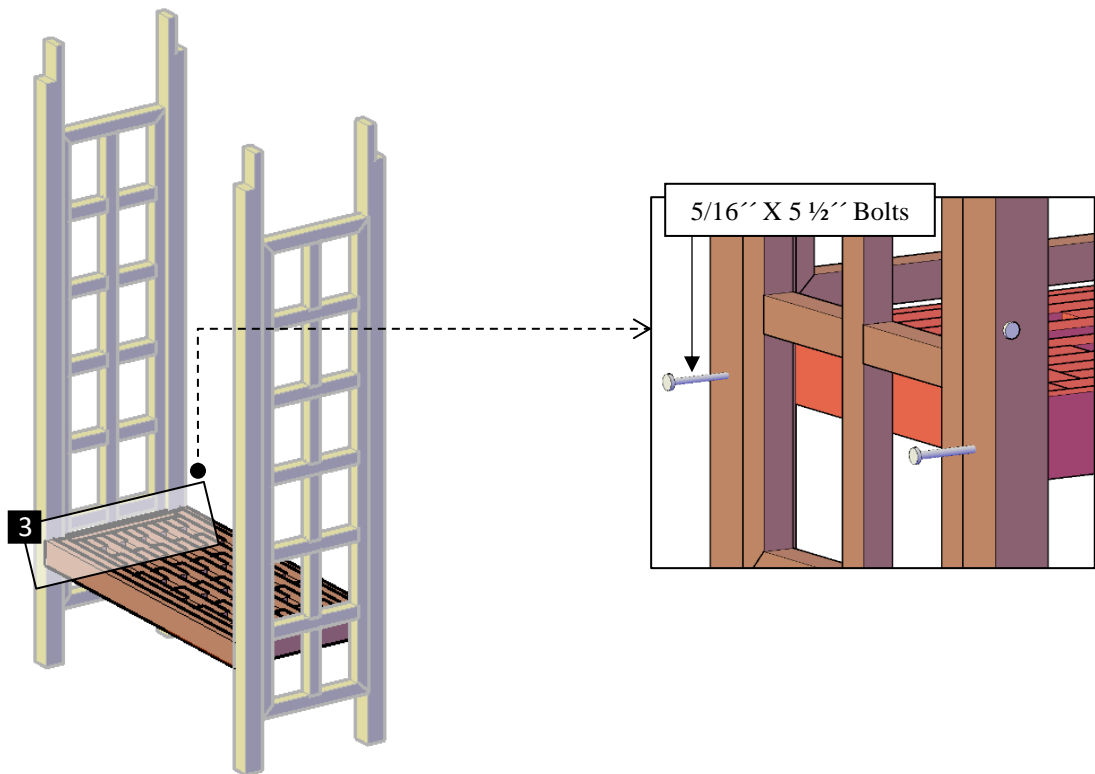

Step 3: Use 5/16" X 2 3/4" bolts (C) with washer and nuts to attach the supports (4) to the posts. Each part has a series of numbers that indicate where to attach the part with the corresponding number.

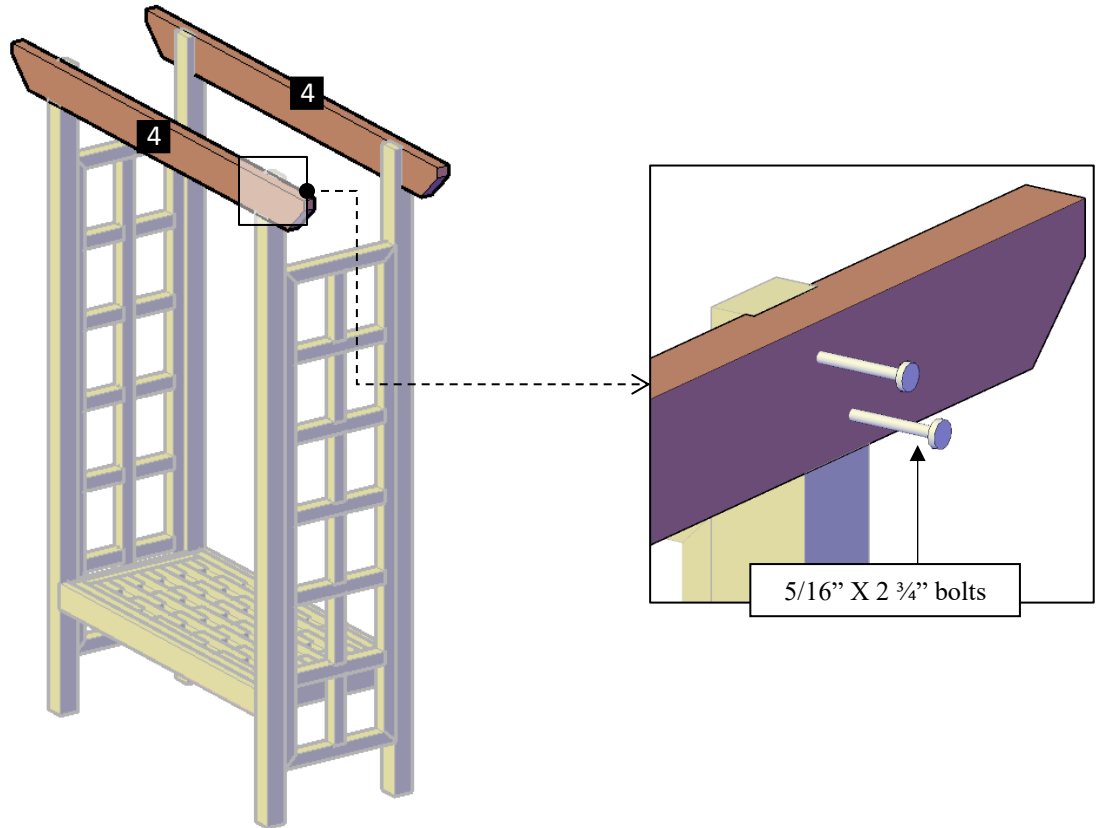

Step 4: Attach the knee braces (5) to the support with 5/16" X 2 3/4" bolts (C) and to the posts with 5/16" x 4 1/2" bolts (B) with washer and nuts. Each part has a series of numbers that indicate where to attach the part with the corresponding number.

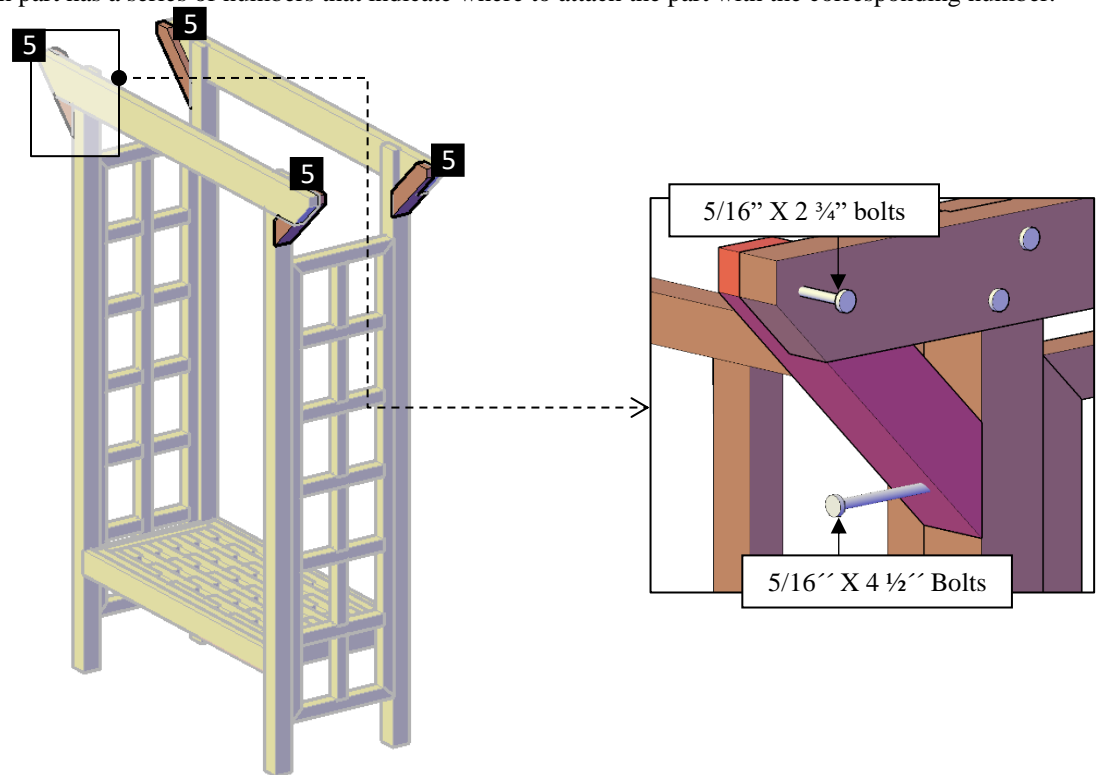

Step 5: Finally, use 3'' deck screws (**D**) to attach each slat (**6**) to the supports. Each part has a series of numbers that indicate where to attach the part with the corresponding number.

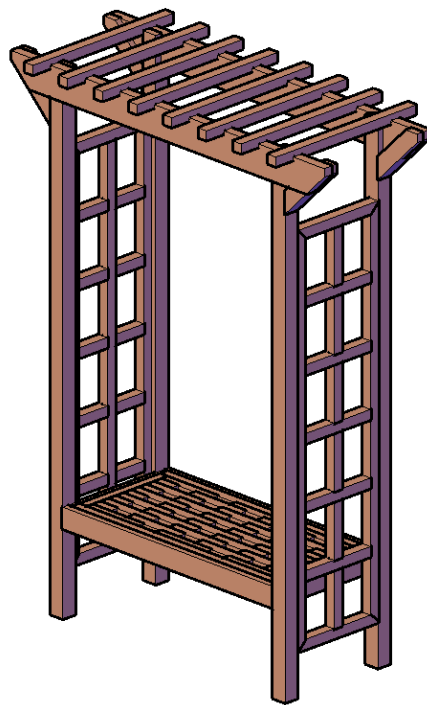
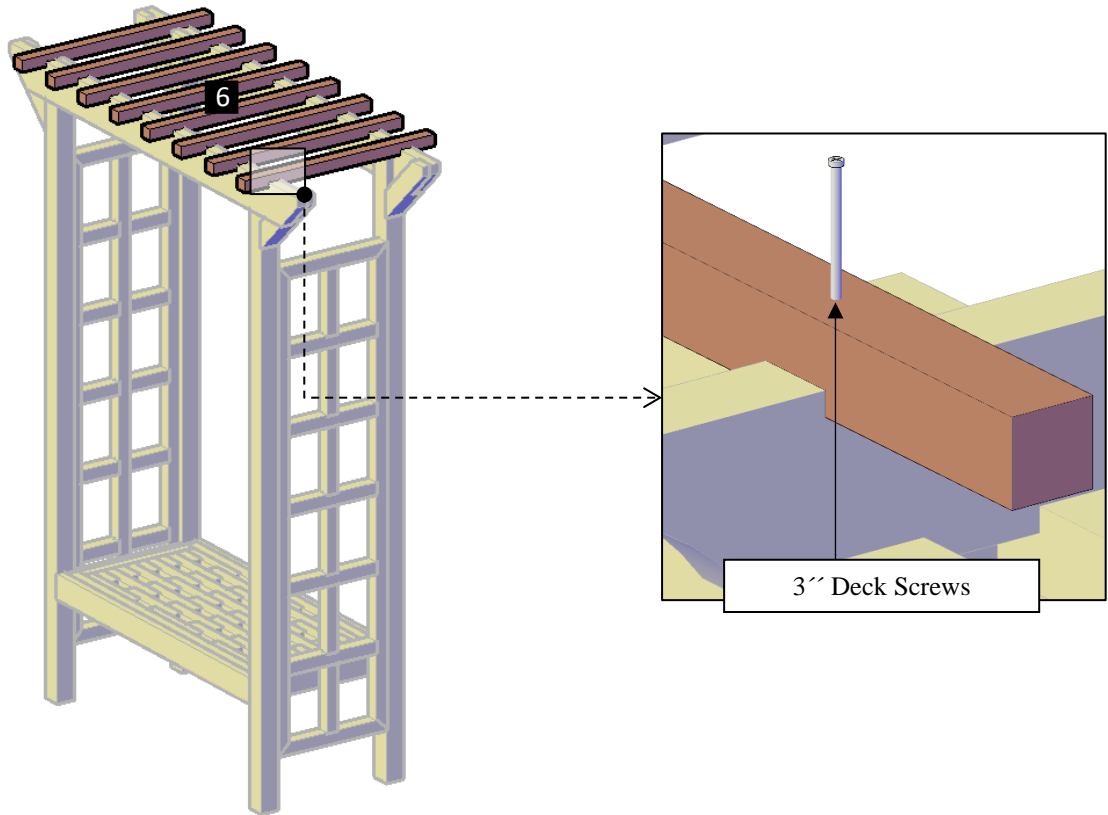

This completes the Arbor Bench assembly. Hope you enjoy your set for many decades. If you ever have a problem or a question, don't hesitate to call us (866 332 2403) or email us. We are here to support you.