



FOREVER REDWOOD

From the Forest, For the Forest since 1995





866.332.2403 (TOLL FREE); 7am – 7pm Pacific Time, Monday-Saturday

ASSEMBLY INSTRUCTIONS FOR THE HERITAGE LARGE WOODEN PICNIC TABLE



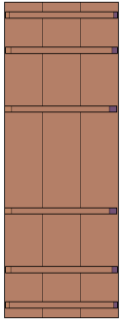
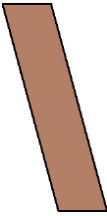
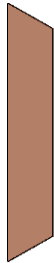

CONTENT OF BOXES

Qty.	Description	Drawing	No.
	Tabletop		1
	Legs		2
Will Vary	Short supports		3
	Long supports		4
	Knee Braces		5
	Bench		6

Note: Part numbers in the Content of Boxes Table are for reference only. These do not match to the numbers marked on the parts sent.

HARDWARE LIST

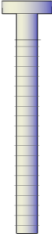
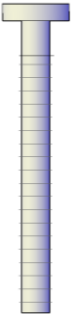
Description	Drawing	No.
5/16" X 3 1/2" Bolts (to attach the legs to the short leg supports and to the long leg supports/to attach the legs to the Tabletop).		A.
5/16" X 4 1/2" Bolts (to attach the knee braces to the legs/to attach the benches to the legs).		B.

Note: Dimensions of your hardware will vary depending on size.



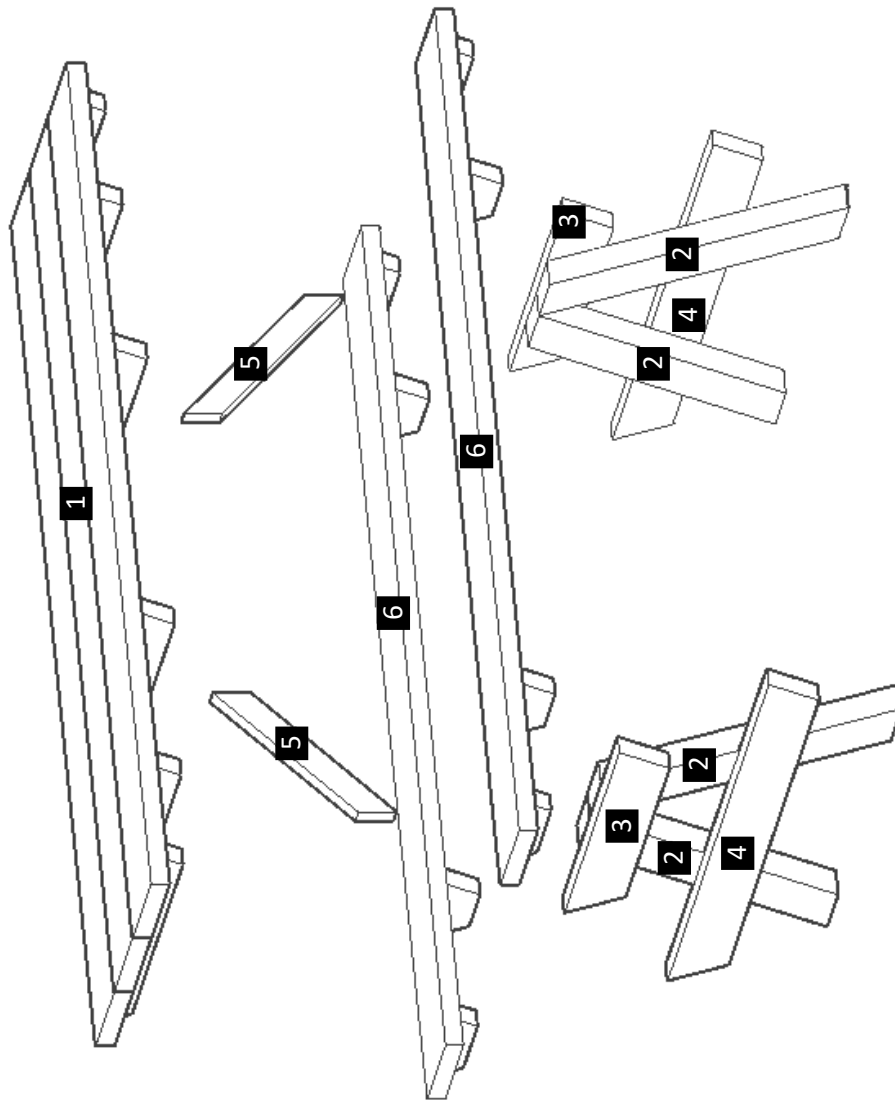

DESCRIPTION	No
Tabletop	1
Legs	2
Short supports	3
Long supports	4
Knee braces	5
Bench	6

Note: Part numbers in the Drawing are for reference only. These do not match to the numbers marked on the parts sent.

Step 1: Attach the legs (2) to the short leg supports (3) and to the long leg supports (4) with 5/16" x 3 1/2" bolts (A). Each part has a series of numbers that indicate where to attach the part with the corresponding number.

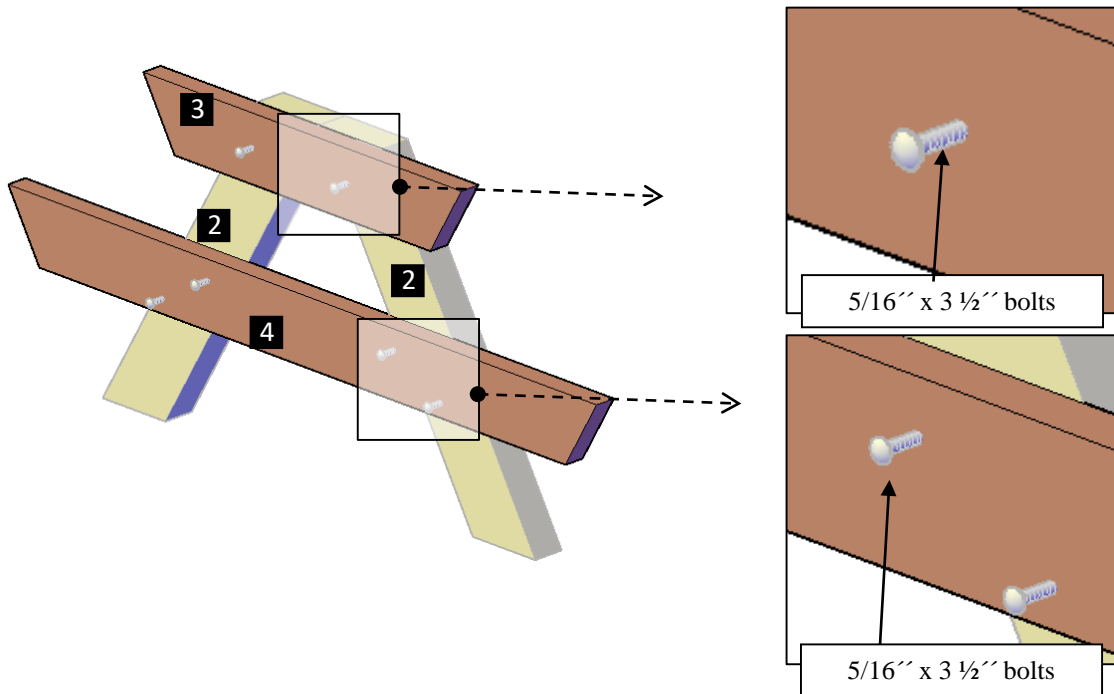

Step 2: Place the Table upside down. After that, use 5/16" x 3 1/2" bolts (A) to attach the legs (2) to the Tabletop (1). Each part has a series of numbers that indicate where to attach the part with the corresponding number.

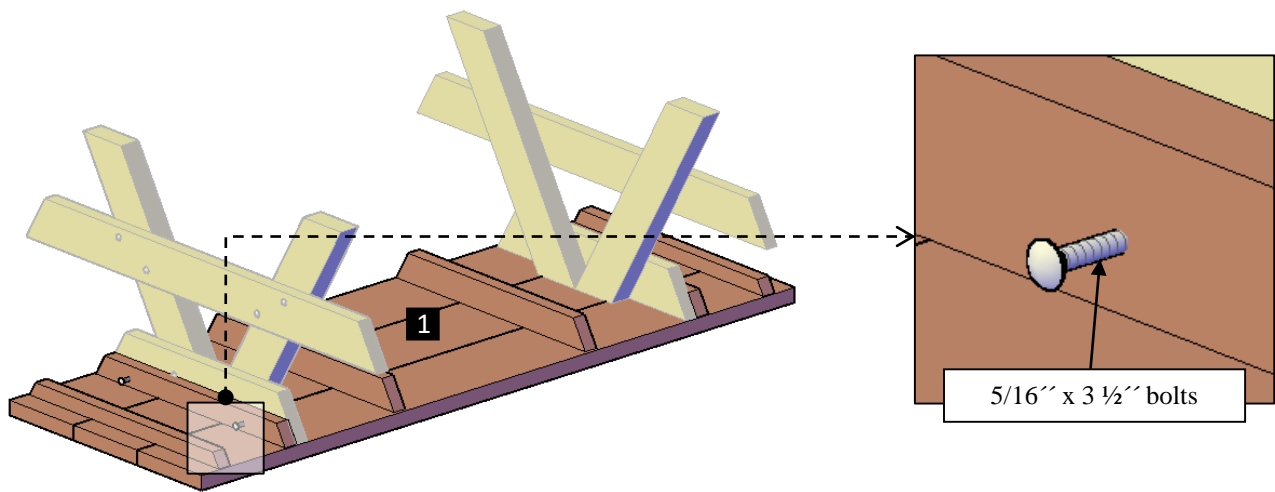

Step 3: Attach the knee braces (5) to the tabletop and to the legs with 5/16" x 3 1/2" bolts (A) and 5/16" x 4 1/2" bolts (B). Each part has a series of numbers that indicate where to attach the part with the corresponding number.

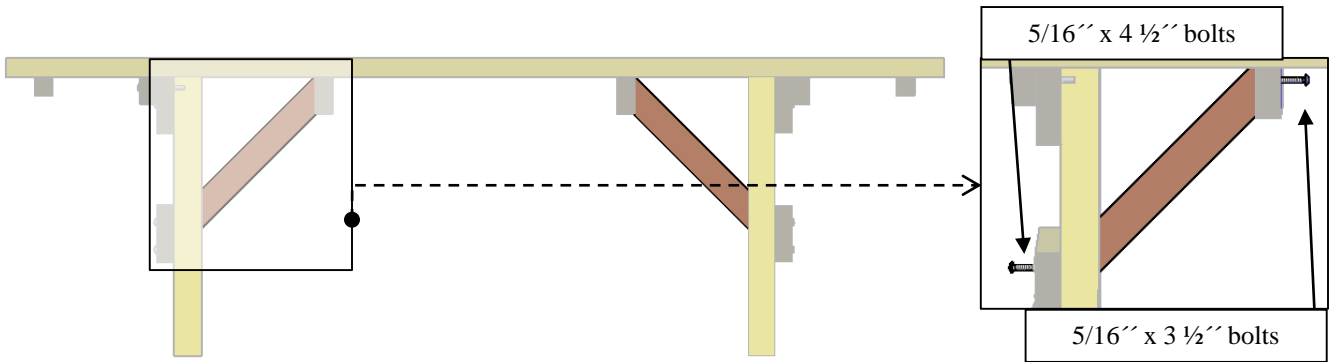

Step 4: Finally, attach the benches (6) to the legs with 5/16" x 4 1/2" bolts (B). Each part has a series of numbers that indicate where to attach the part with the corresponding number.

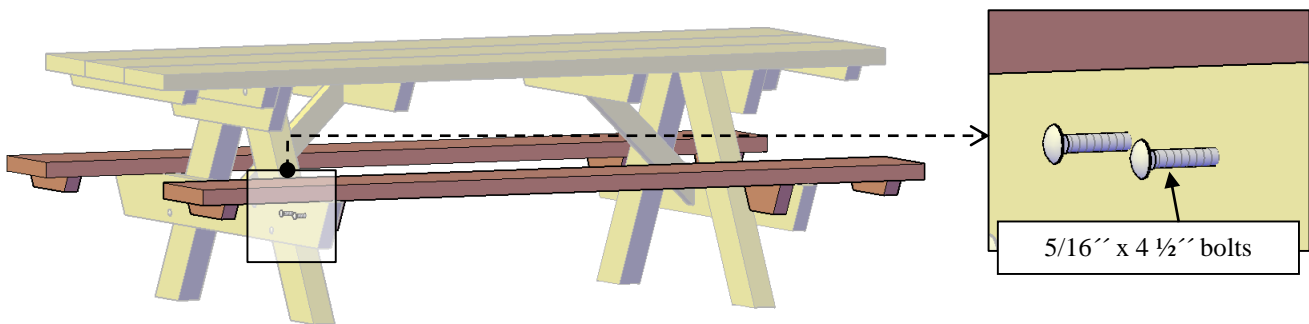

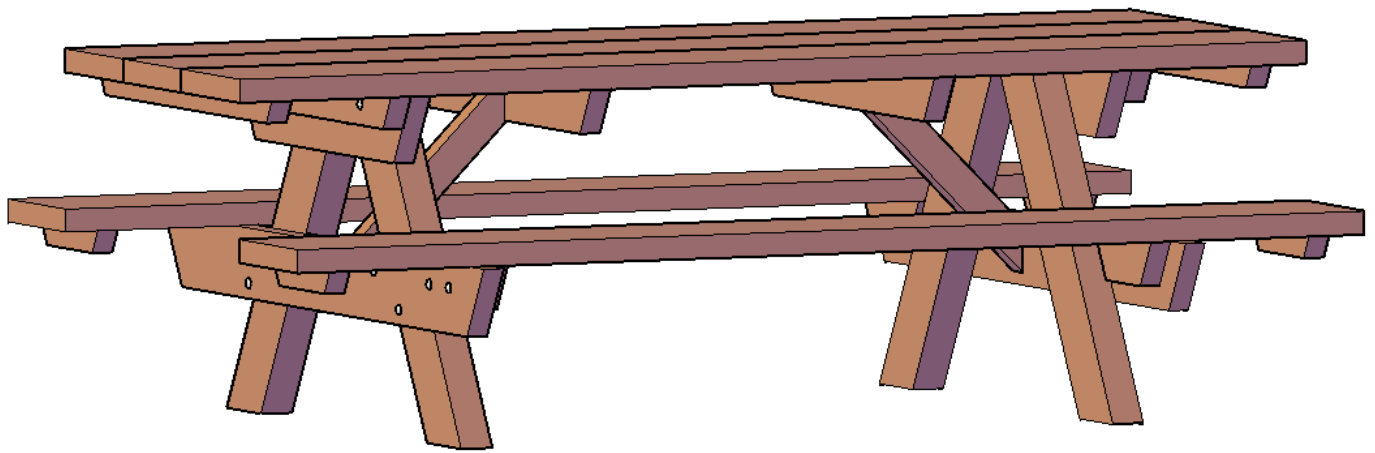

This completes the picnic table assembly. Hope you enjoy your set for many decades. If you ever have a problem or a question, don't hesitate to call us (866 332 2403) or email us. We are here to support you.