



FOREVER REDWOOD

From the Forest, For the Forest since 1995

866.332.2403 (TOLL FREE); 7am – 7pm Pacific Time, Monday-Saturday

ASSEMBLY INSTRUCTIONS FOR THE LAILA'S STORAGE SPA STEP



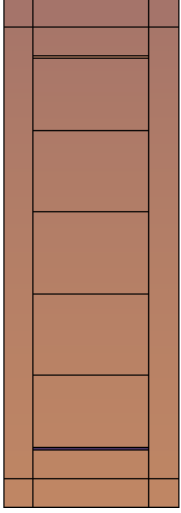
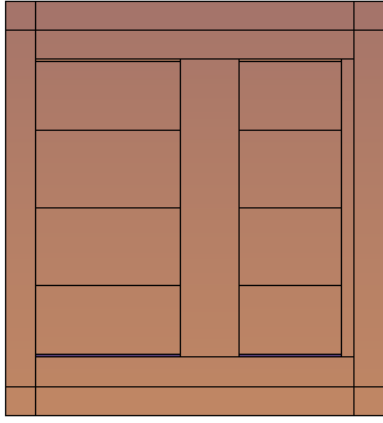
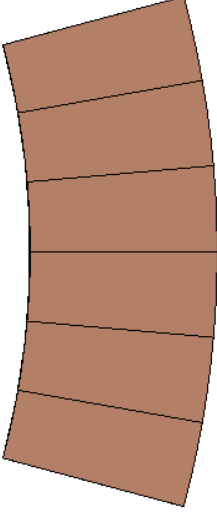
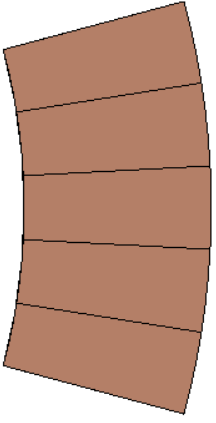

CONTENT OF BOXES

Qty.	Description	Drawing	No.
1	Step 1		1
1	Step 2		2
1	Storage Cover 1		3
1	Storage Cover 2		4

Note: Part numbers in the Content of Boxes Table are for reference only. These do not match to the numbers marked on the parts sent.



CONTENT OF BOXES

Qty.	Description	Drawing	No.
6	5/16" x 2" Bolts (To attach the bench seat to the legs).		a
6	Nuts		b
6	Washers		c

Note: Dimensions of your hardware will vary depending on size.

DESCRIPTION	No.
Step 1	1
Step 2	2
Storage Cover 1	3
Storage Cover 2	4
5/16" x 3" Bolts	a

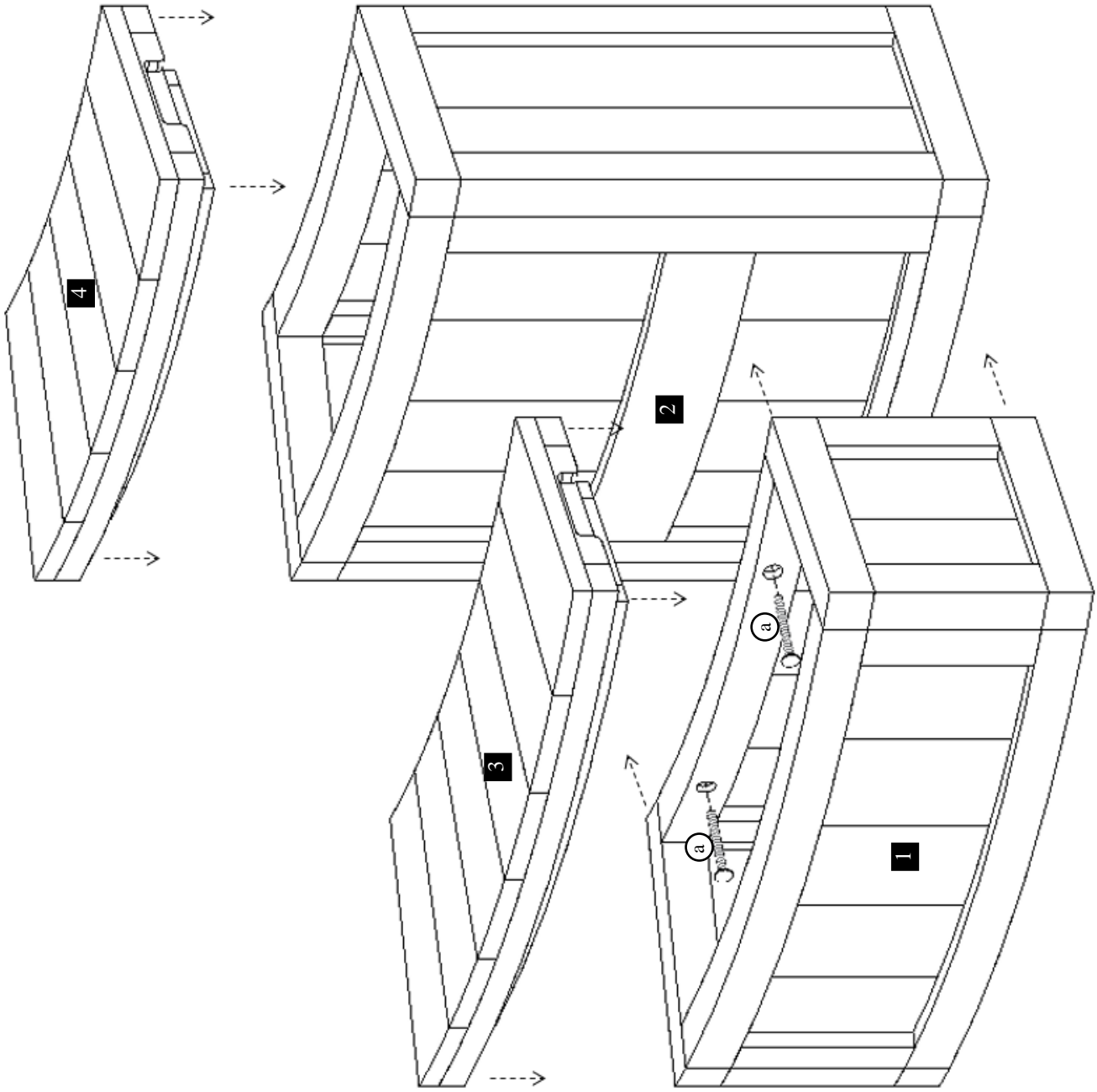

Note: Part numbers in the Drawing are for reference only. These do not match to the numbers marked on the parts sent.

Step 1: Use 5/16" x 3" bolts (a), nuts (b) and washers (b) to attach the steps (1,2) together. Each part has a series of numbers that indicate where to attach the part with the corresponding number.

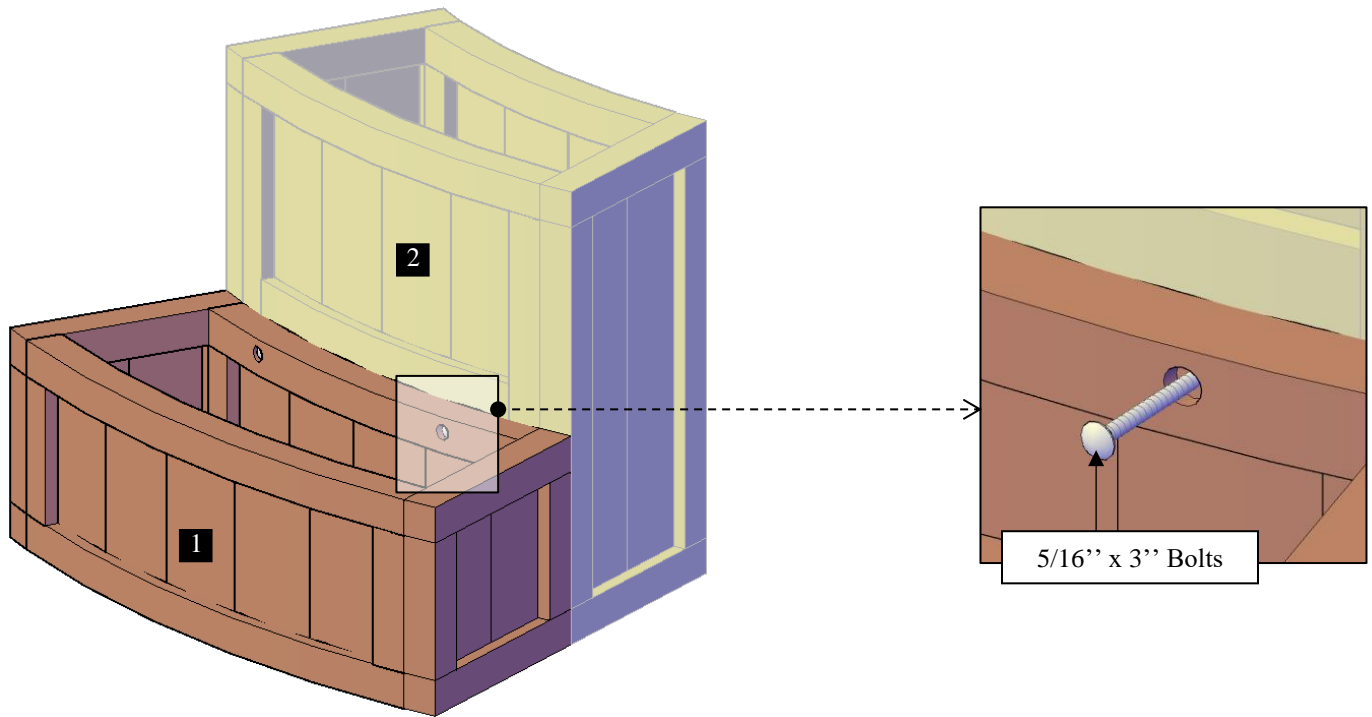

Step 2: Finally, Place the storage covers (3,4) on the corresponding step.

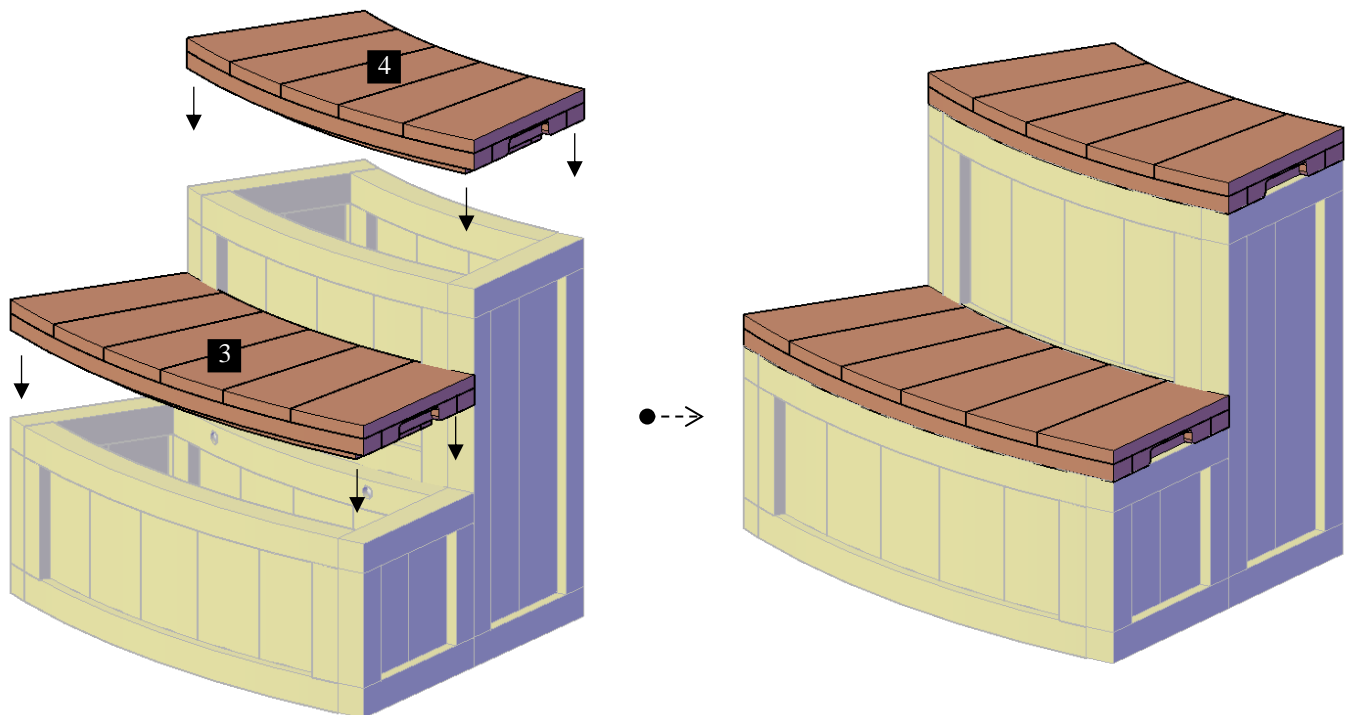



This completes the Laila's Storage Spa Step Assembly. Hope you enjoy your set for many decades. If you ever have a problem or a question, don't hesitate to call us (866 332 2403) or email us. We are here to support you.