



FOREVER REDWOOD

From the Forest, For the Forest since 1995



866.332.2403 (TOLL FREE); 7am – 7pm Pacific Time, Monday-Saturday

ASSEMBLY INSTRUCTIONS FOR THE **MASSIVE WOODEN ROCKING CHAIR**





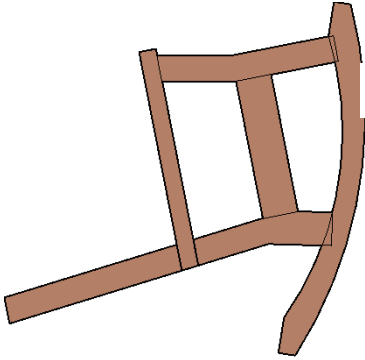
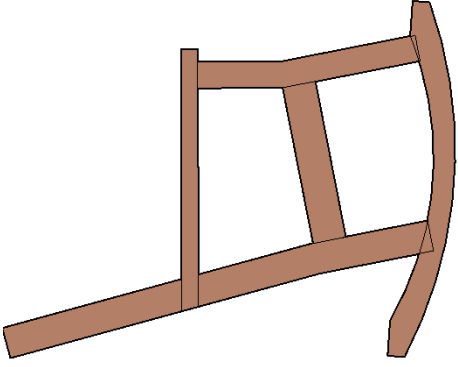

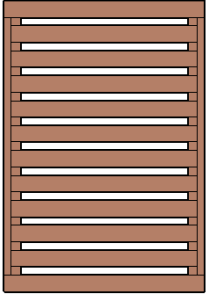
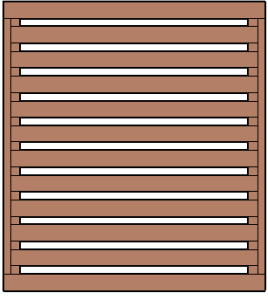
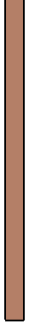
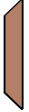
CONTENT OF BOXES

Qty.	Description	Drawing		No.
2	Legs Deep Style or Tall Style			1
1	Seat	<div style="display: flex; justify-content: space-around;"> <div data-bbox="735 1031 1034 1375">Deep Style </div> <div data-bbox="797 247 1034 972">Tall Style </div> </div>		2
1	Backrest			3
1	Front Support			4
2	Diagonal Supports (Only for tall rocking chair)			5

Note: Part numbers in the Content of Boxes Table are for reference only. T

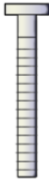

HARDWARE LIST

Description	Drawing	No.
3/8'' X 3 1/2'' Bolts (To attach the seat and the backrest to the legs / To attach the diagonal supports to the seat).		A
3/8'' X 4 1/2'' Bolts (To attach the frontal support and the diagonal supports to the legs)		B

Note: Dimensions of your hardware will vary depending on size.



DESCRIPTION	No
Legs	1
Seat	2
Backrest	3
Front Support	4
Diagonal Supports	5

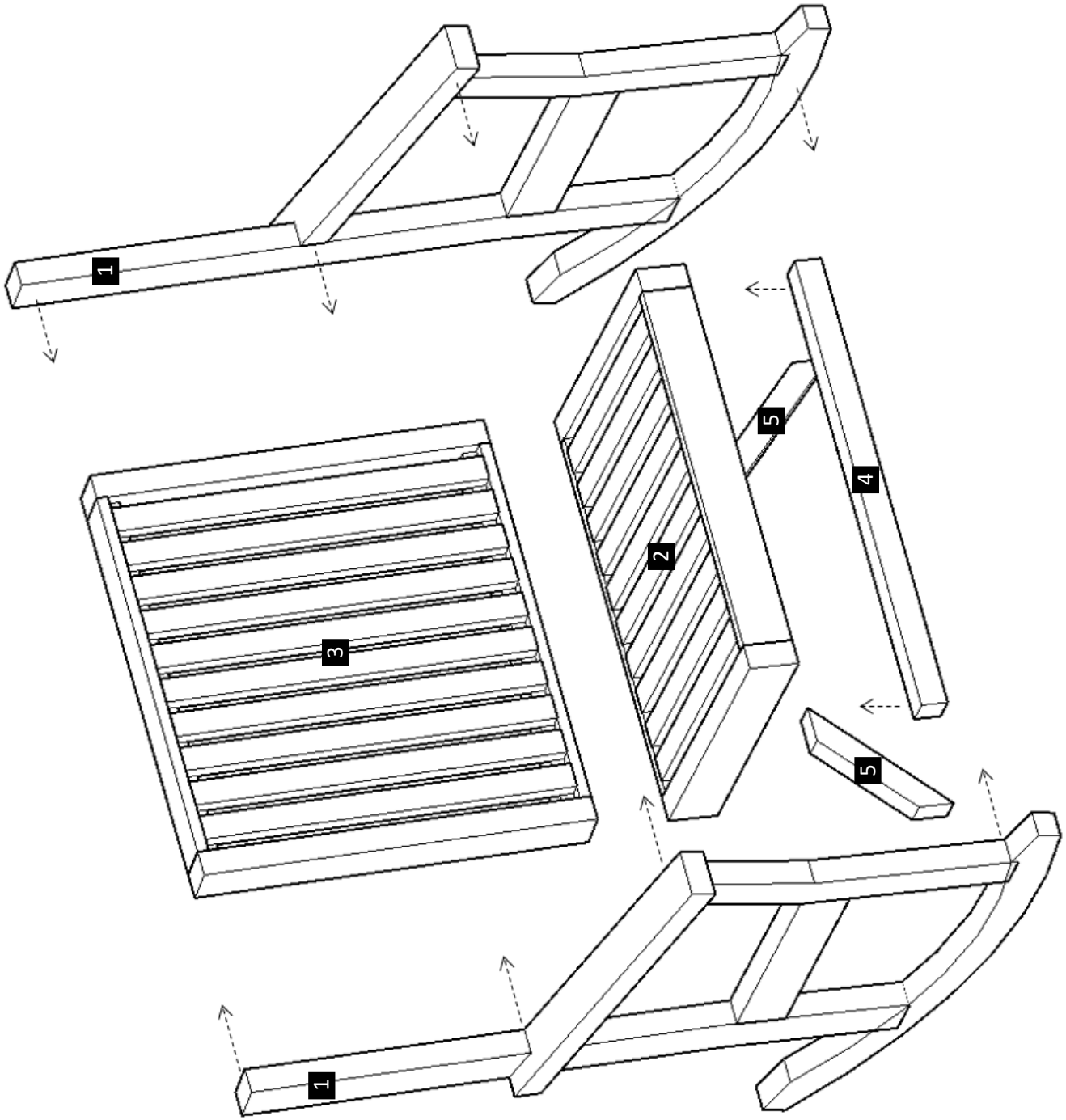

Note: Part numbers in the Drawing are for reference only. These do not match to the numbers marked on the parts sent.

Step 1: Use 5/16" x 3 1/2" bolts (A) to attach the legs (1) to the seat (2). Each part has a series of numbers that indicate where to attach the part with the corresponding number.

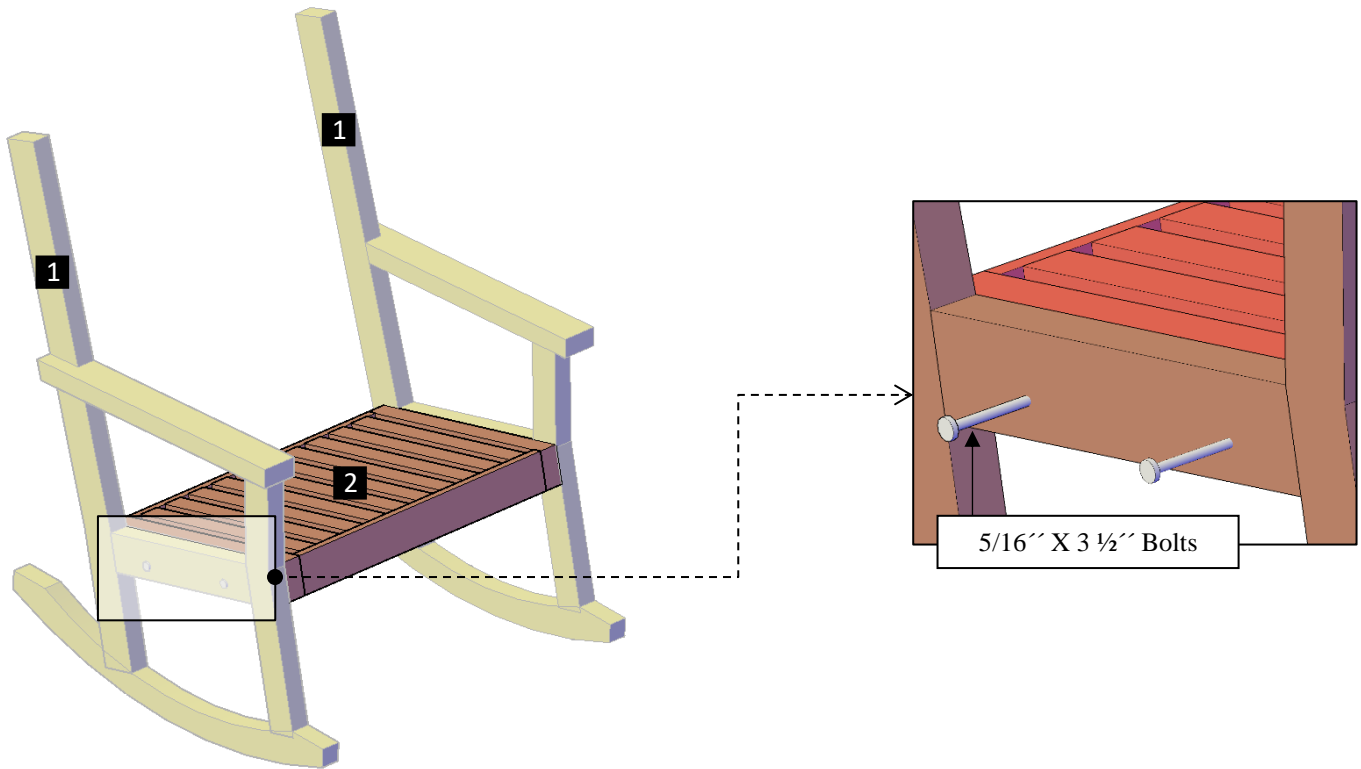

Step 2: Attach the backrest (3) to the legs with 5/16" x 3 1/2" bolts (A). Each part has a series of numbers that indicate where to attach the part with the corresponding number.

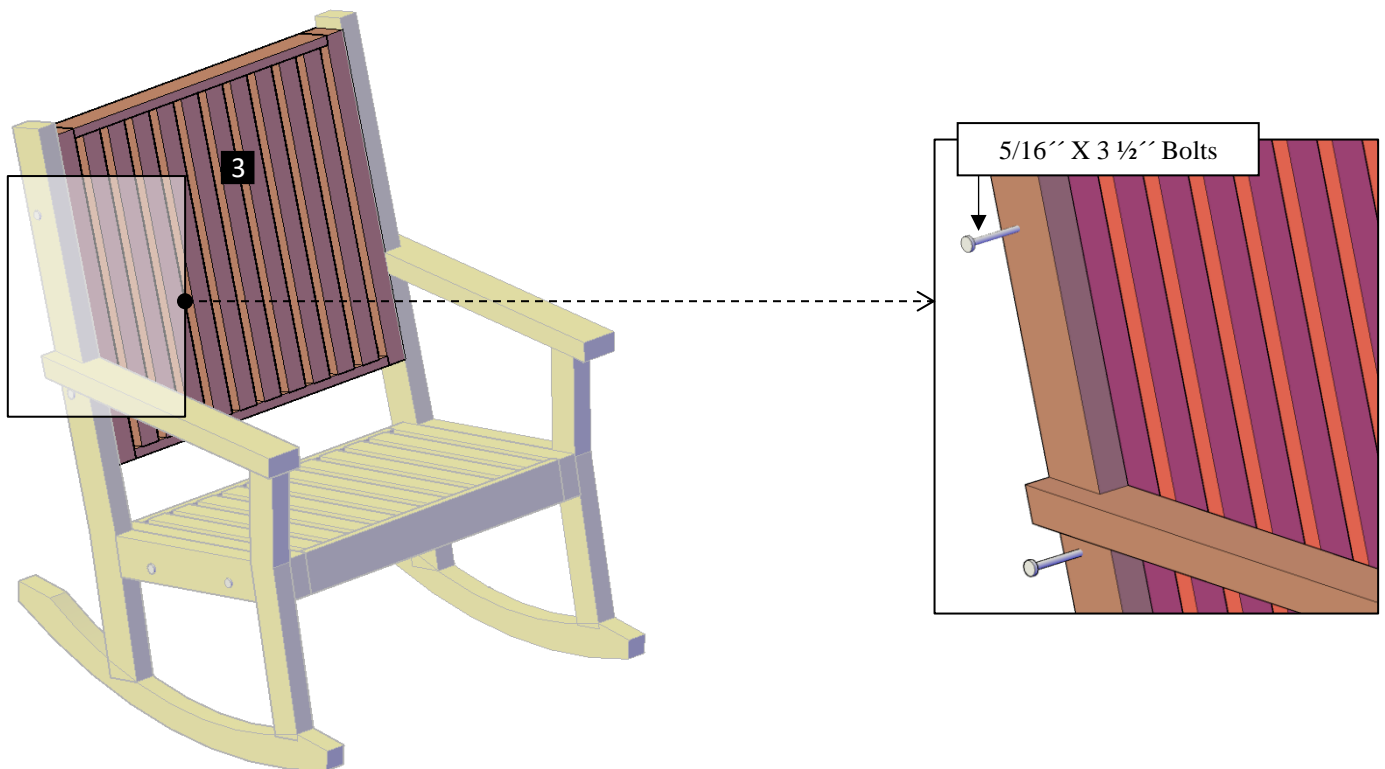

Step 3: Attach the frontal support (4) to the legs with 5/16" x 4 1/2" bolts (B). Each part has a series of numbers that indicate where to attach the part with the corresponding number.

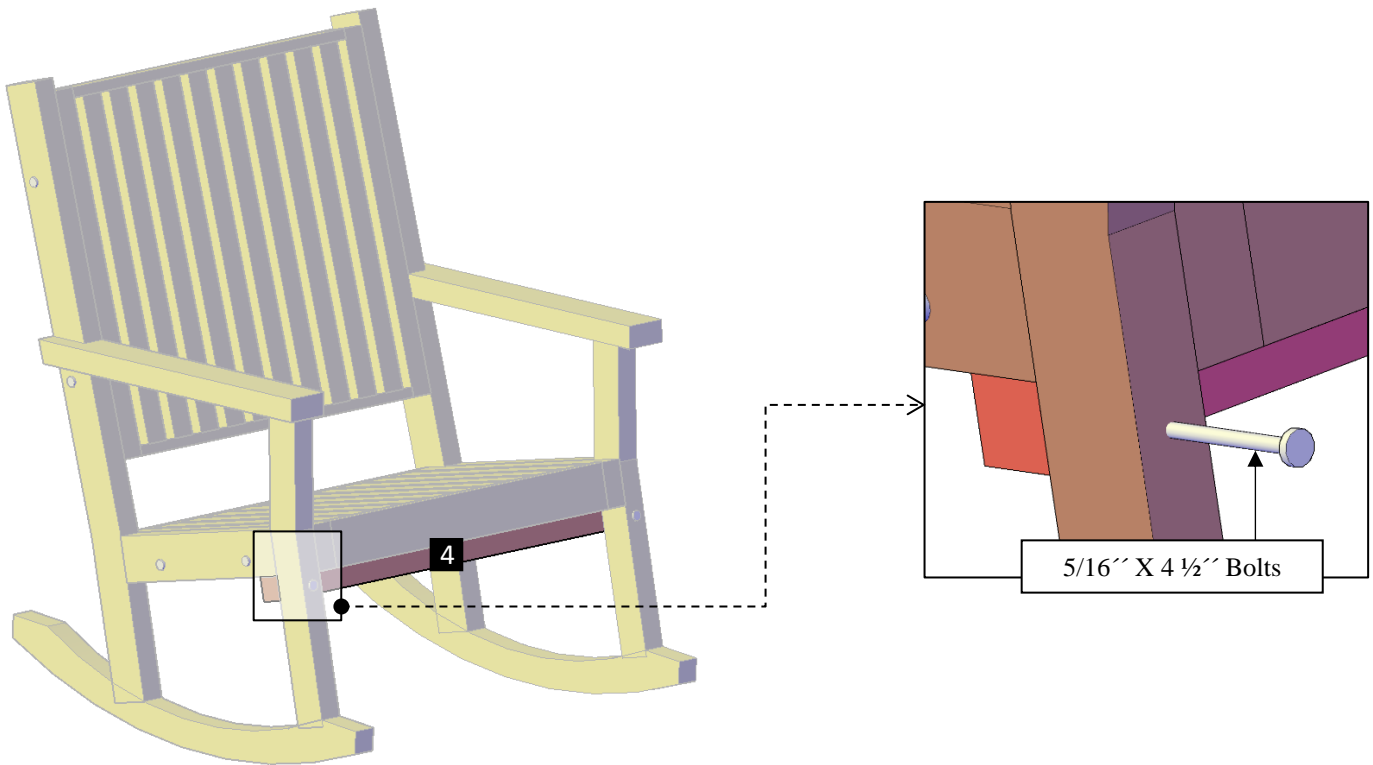

Finally, if your chair includes diagonal supports, then follow this instruction.

Step 4: Use 5/16" x 3 1/2" bolts (A) to attach the diagonal supports (5) to the seat. After that, use 5/16" x 4 1/2" (B) bolts to attach to the legs. Each part has a series of numbers that indicate where to attach the part with the corresponding number.

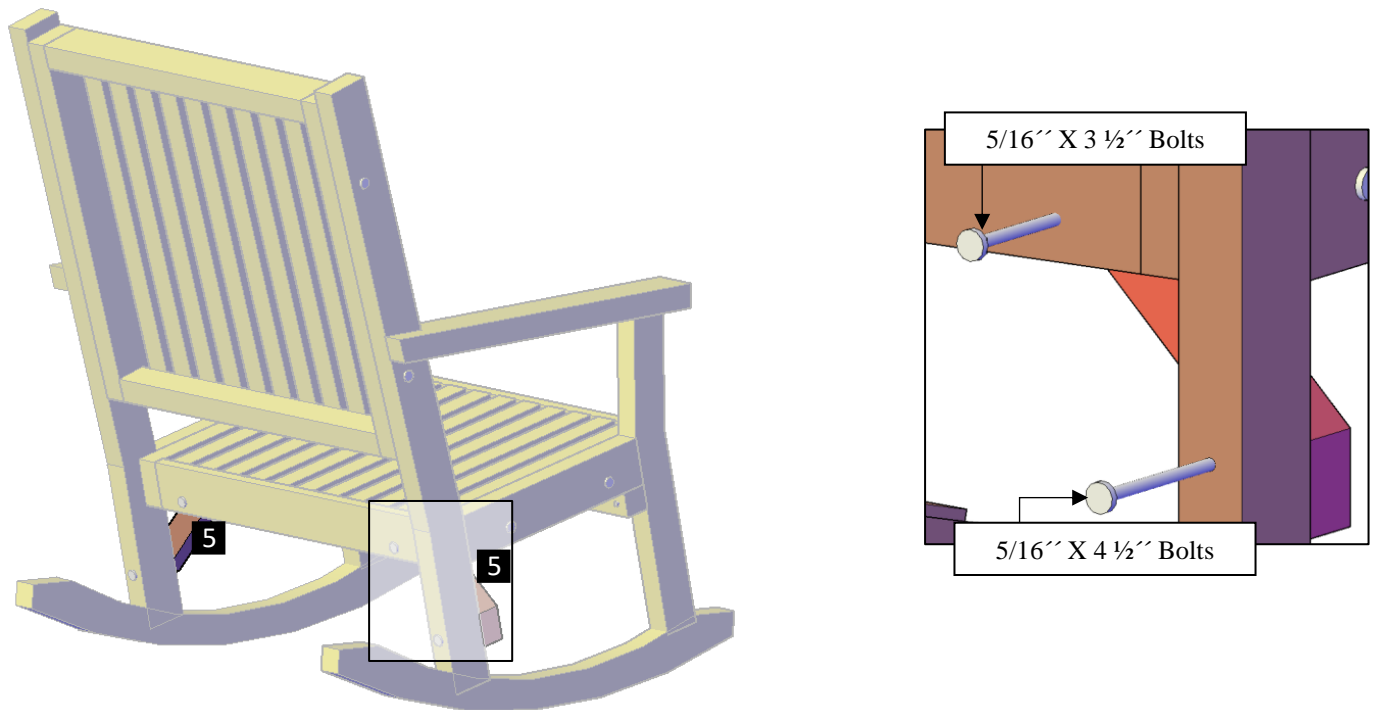

Massive Wood Rocking Chair – Deep Style



Massive Wood Rocking Chair – Tall Style





This completes the Rocking Chair assembly. Hope you enjoy your set for many decades. If you ever have a problem or a question, don't hesitate to call us (866 332 2403) or email us. We are here to support you.