



FOREVER REDWOOD

From the Forest, For the Forest since 1995



866.332.2403 (TOLL FREE); 7am – 7pm Pacific Time, Monday-Saturday

ASSEMBLY INSTRUCTIONS FOR THE **PRIVACY SCREENS**





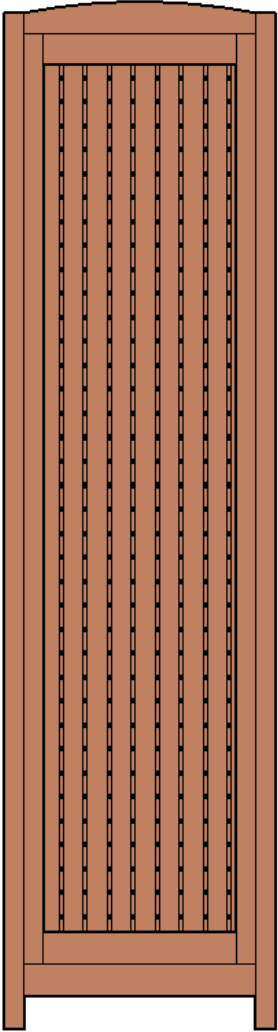

CONTENT OF BOXES

Qty.	Description	Drawing	No.
Will Vary	Screen Panels		1
	Legs If Ordered		2

Note: Part numbers in the Content of Boxes Table are for reference only. These do not match to the numbers marked on the parts sent.



HARDWARE LIST

Description	Drawing	No.
5/16'' X 3 1/2'' Bolts (To attach the legs to the screen panels).		A
Washers		B
5/16'' Nuts		C

Note: Dimensions of your hardware will vary depending on size.



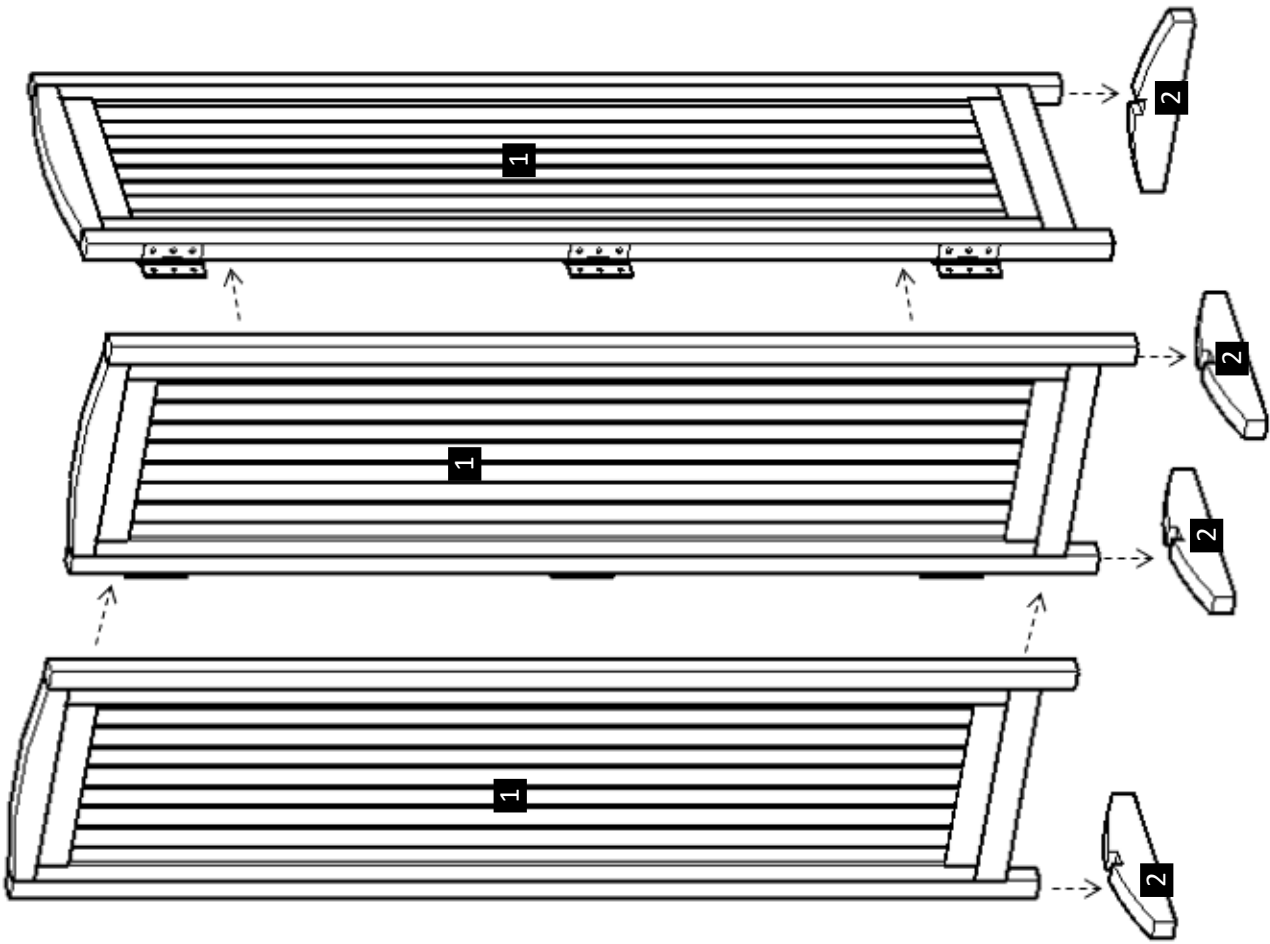

DESCRIPTION	No
Screen Panels	1
Legs	2

Note: Part numbers in the Drawing are for reference only. These do not match to the numbers marked on the parts sent.

Step 1: First, attach the legs (2) to the screen panels (1) with 5/16" X 3 1/2" bolts (A). Each part has a series of numbers that indicate where to attach the part with the corresponding number.

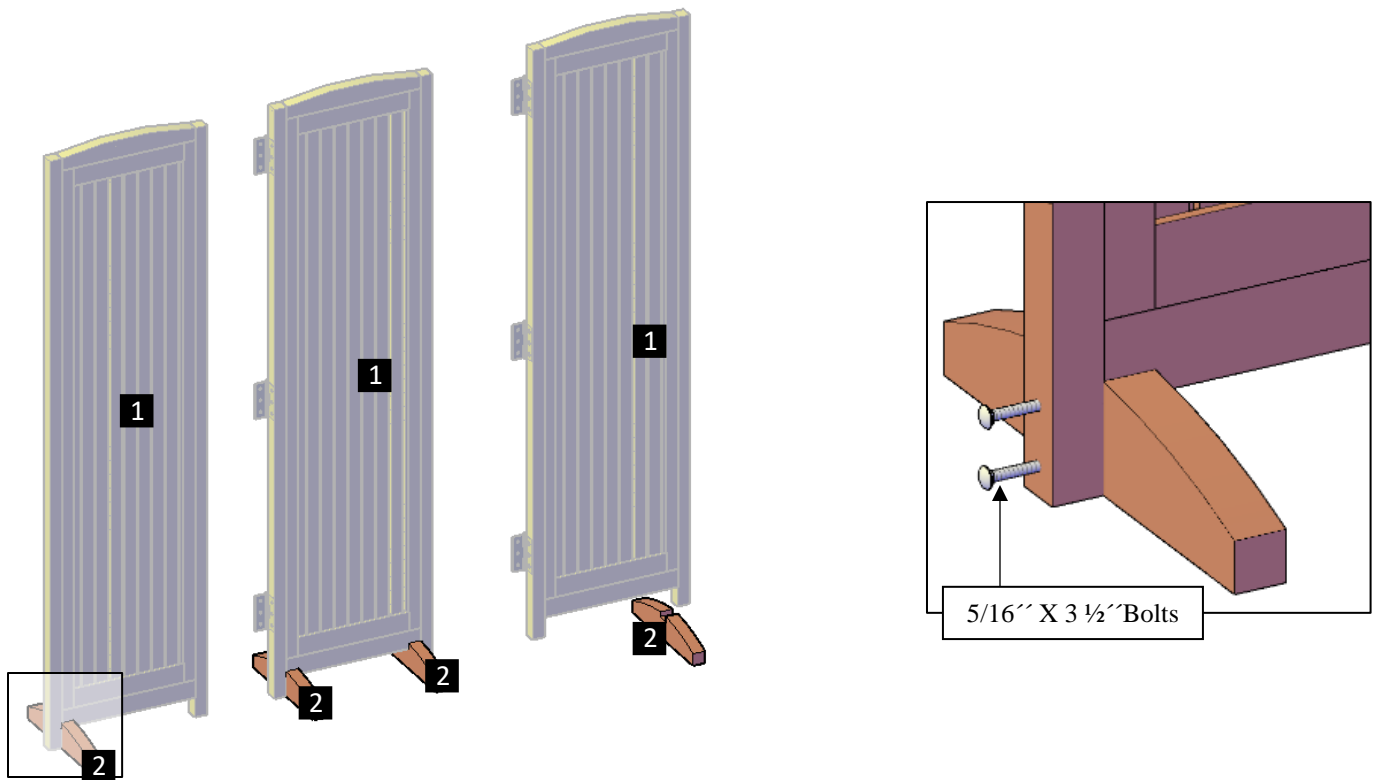

Step 2: Attach the hinges to the screen panels with its corresponding deck screws. Each part has a series of numbers that indicate where to attach the part with the corresponding number.

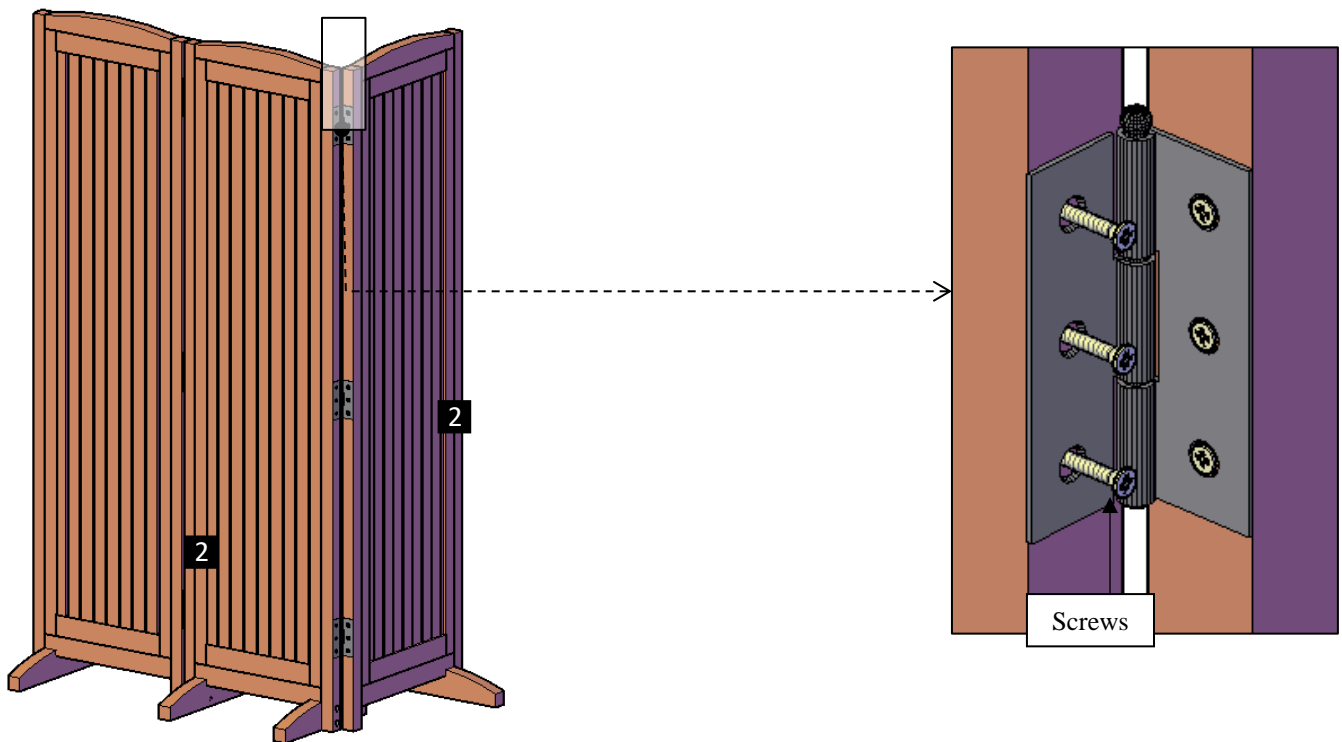



This completes the Privacy Screen assembly. Hope you enjoy your set for many decades. If you ever have a problem or a question, don't hesitate to call us (866 332 2403) or email us. We are here to support you.