



FOREVER REDWOOD

From the Forest, For the Forest since 1995

866.332.2403 (TOLL FREE); 7am – 7pm Pacific Time, Monday-Saturday

ASSEMBLY INSTRUCTIONS FOR THE TERRACE ROUND WOODEN TABLE



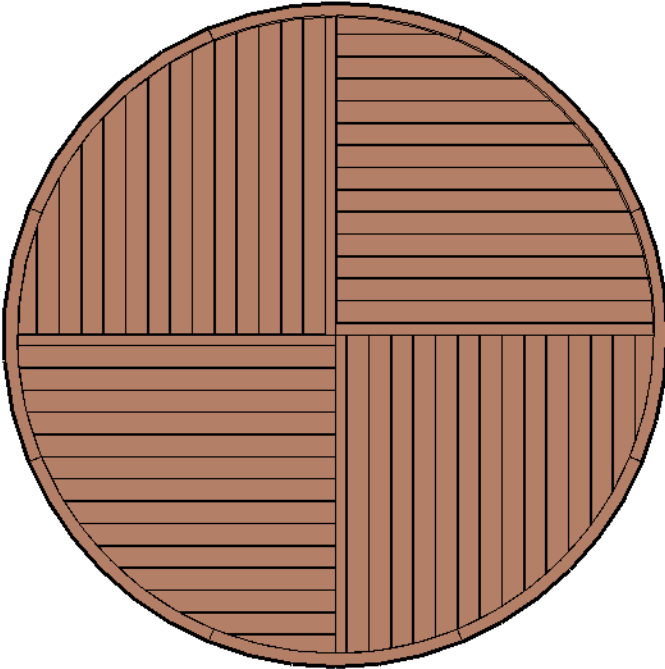
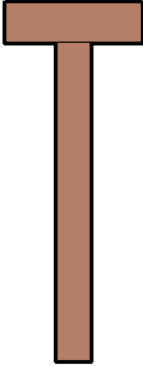

CONTENT OF BOXES

Qty.	Description	Drawing	No.
1	Tabletop		1
4	Legs		2

Note: Part numbers in the Content of Boxes Table are for reference only. These do not match to the numbers marked on the parts sent.



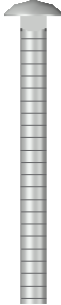
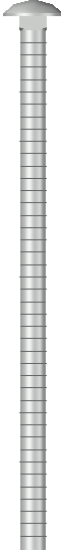

HARDWARE LIST		
Description	Drawing	No.
5/16" x 3 1/2" Bolts (To attach the tabletop to the legs).		A
5/16" x 6 1/2" Bolts (To attach the tabletop to the legs).		B

Note: Dimensions of your hardware will vary depending on size.



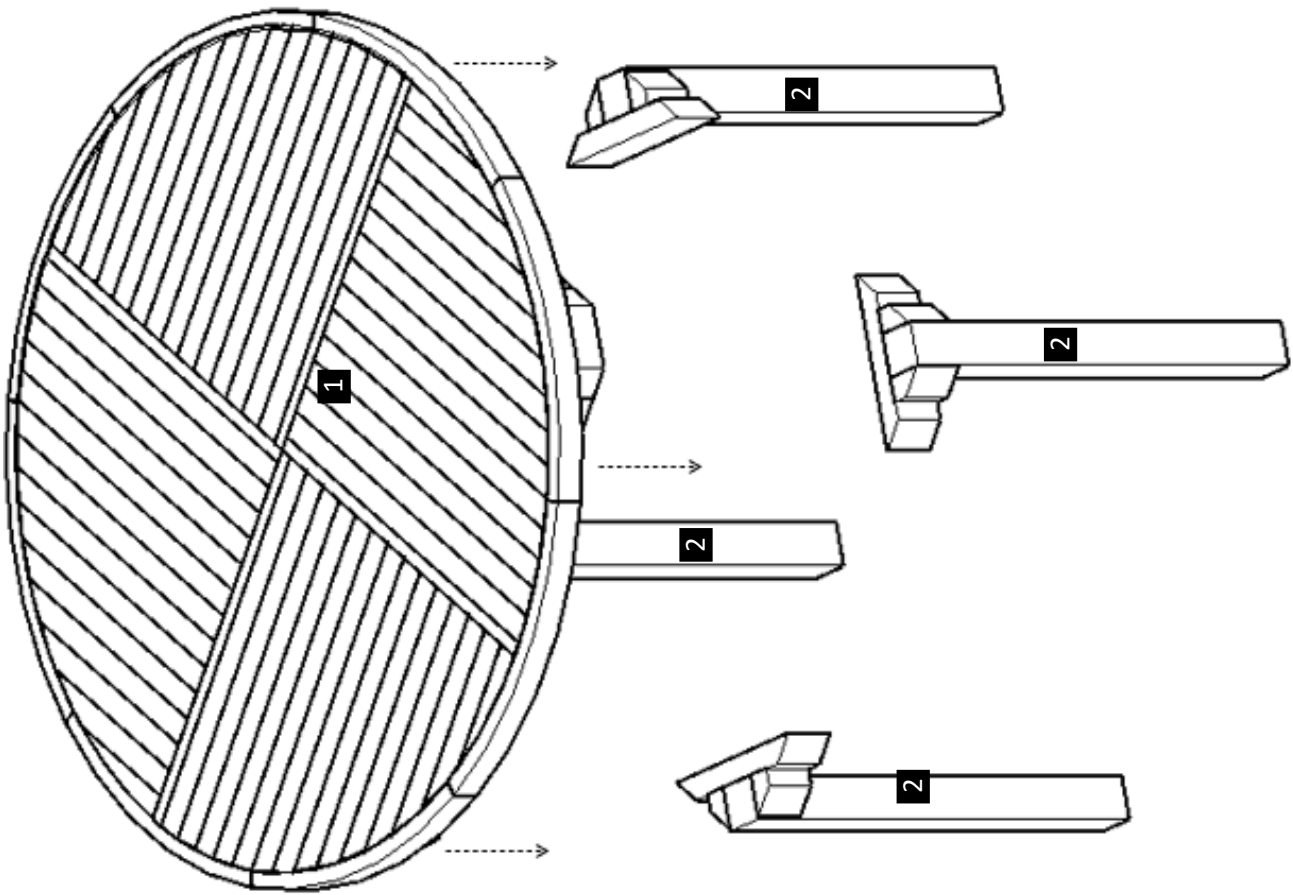

DESCRIPTION	No
Tabletop	1
Legs	2

Note: Part numbers in the Drawing are for reference only. These do not match to the numbers marked on the parts sent.

Step 1: Place the tabletop upside down. After that, use 5/16" X 3 1/2" bolts (A) and 5/16" x 6 1/2" bolts (B) to attach each leg (2) to the tabletop (1). Each part has a series of numbers that indicate where to attach the part with the corresponding number.

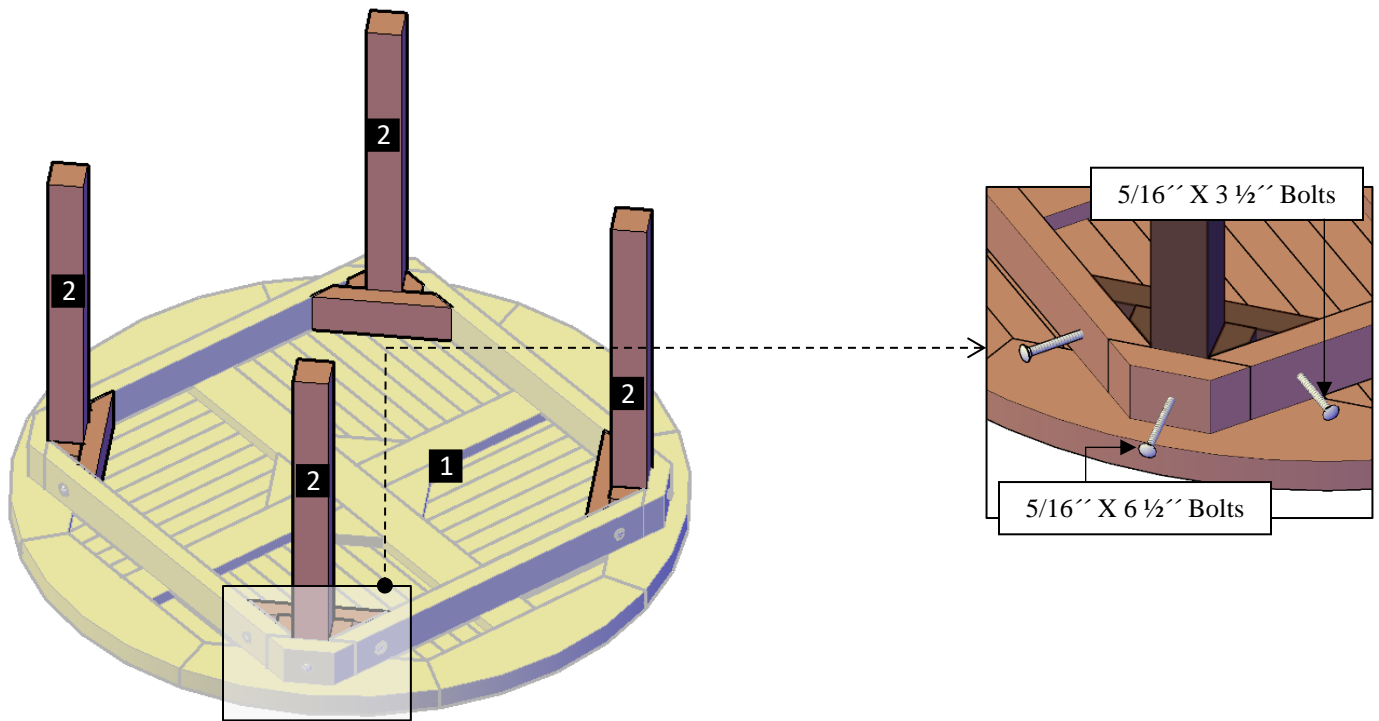

Step 2: Finally, turn the table over its feet.

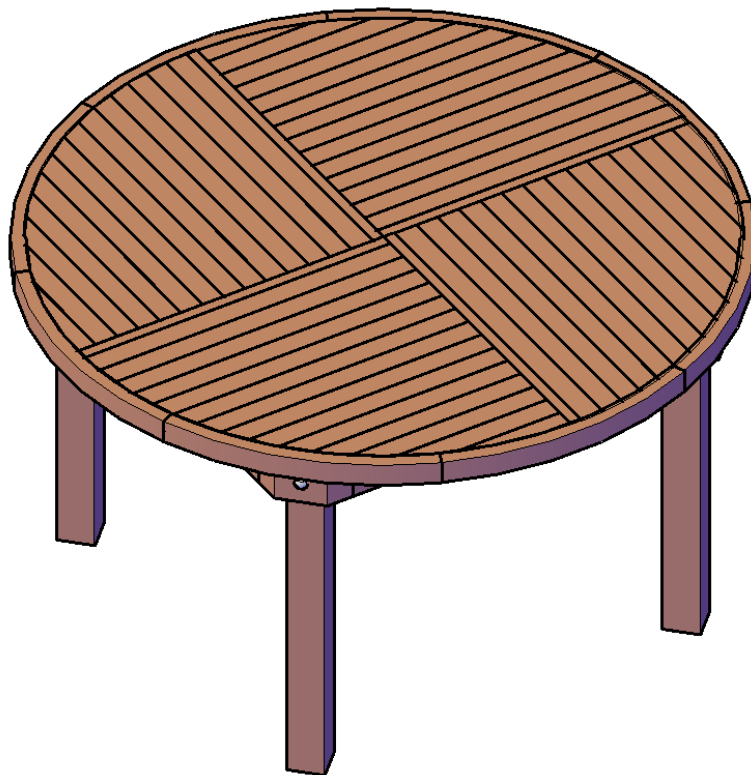



This completes the Table assembly. Hope you enjoy your set for many decades. If you ever have a problem or a question, don't hesitate to call us (866 332 2403) or email us. We are here to support you.