



FOREVER REDWOOD

From the Forest, For the Forest since 1995

866.332.2403 (TOLL FREE); 7am – 7pm Pacific Time, Monday-Saturday

ASSEMBLY INSTRUCTIONS FOR THE THE LIGHTHOUSE ROCKING CHAIR







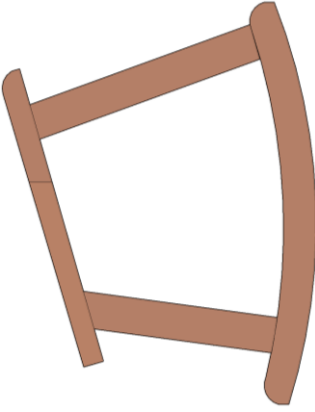

CONTENT OF BOXES

Qty.	Description	Drawing	No.
1	Backrest		1
1	Seat		2
2	Legs		3

Note: Part numbers in the Content of Boxes Table are for reference only. These do not match to the numbers marked on the parts sent.

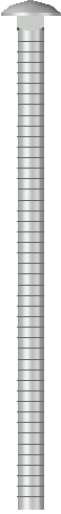
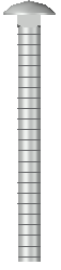
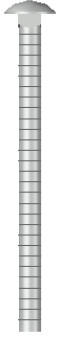

HARDWARE LIST

Description	Drawing	No.
<p>3/8" X 7" Bolts (To attach the backrest to the seat).</p>		A
<p>5/16" X 3 1/2" Bolts (To attach the legs to the seat).</p>		B
<p>5/16" X 4 1/2" Bolts (To attach the legs to the backrest).</p>		C
<p>3/8" , Nuts</p>		D
<p>5/16" Nuts</p>		E
<p>3/8" x 7/8" Washers</p>		F

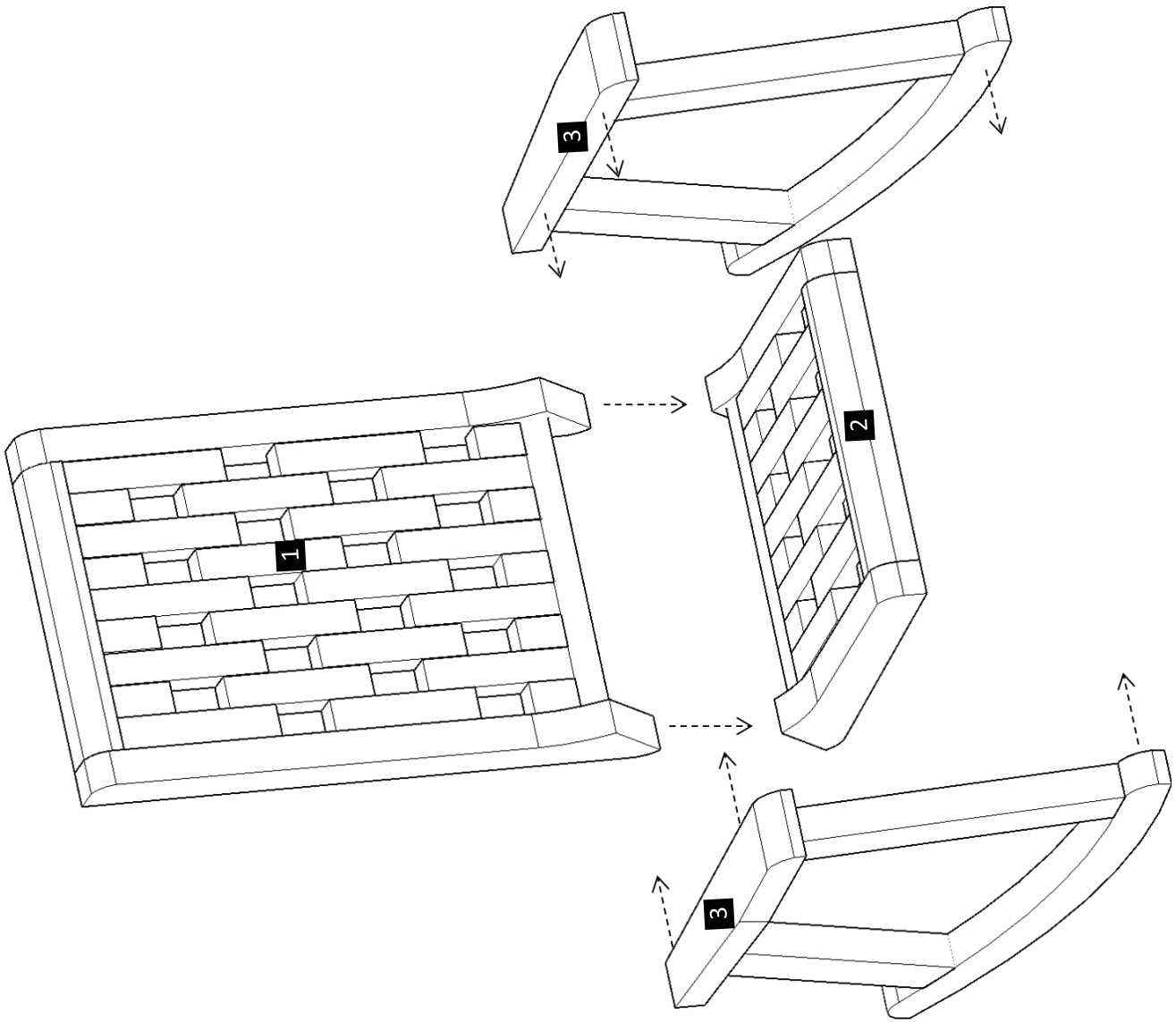

DESCRIPTION	No
Backrest	1
Seat	2
Legs	3

Note: Part numbers in the Drawing are for reference only. These do not match to the numbers marked on the parts sent.

Step 1: Use 3/8" X 7" bolts (A) to attach the backrest (1) to the seat (2). Each part has a series of numbers that indicate where to attach the part with the corresponding number.

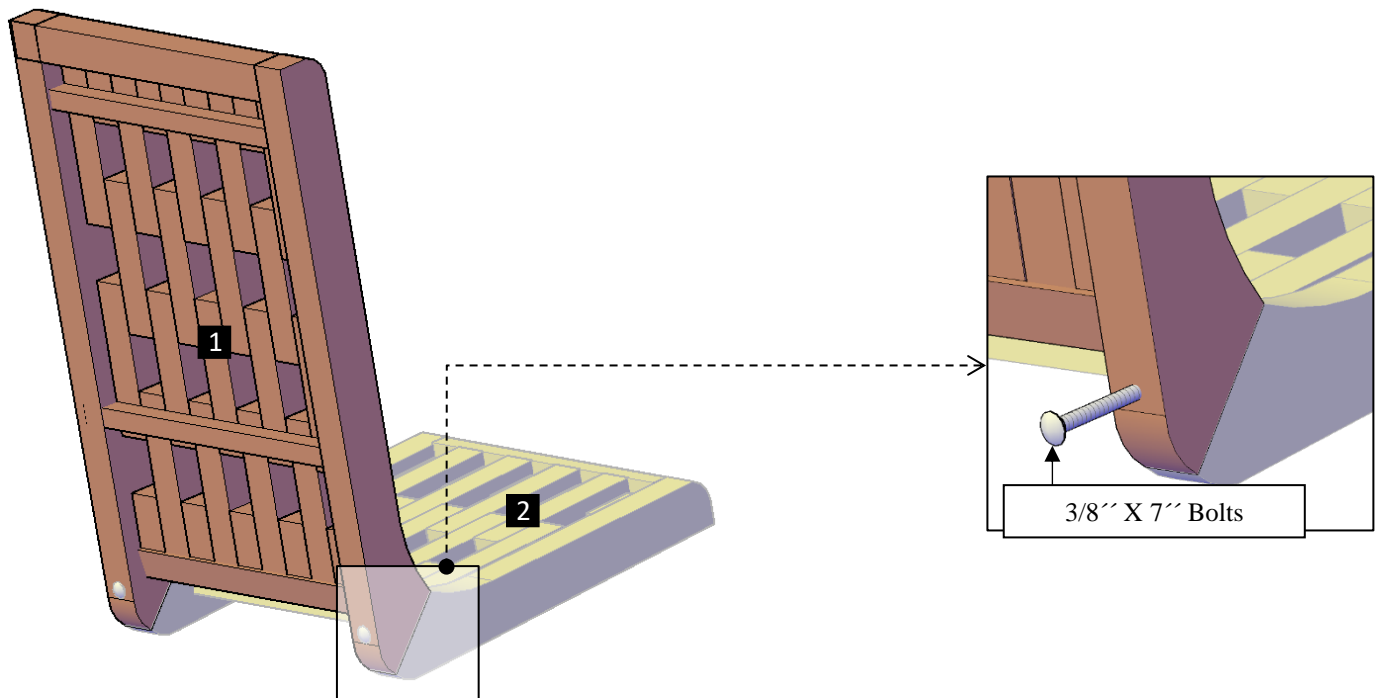

Step 2: Finally, attach the legs (3) to the seat and to the backrest with 5/16" x 3 1/2" bolts (B). After that use 5/16" x 4 1/2" bolts (C) to attach the legs to the backrest. Each part has a series of numbers that indicate where to attach the part with the corresponding number.

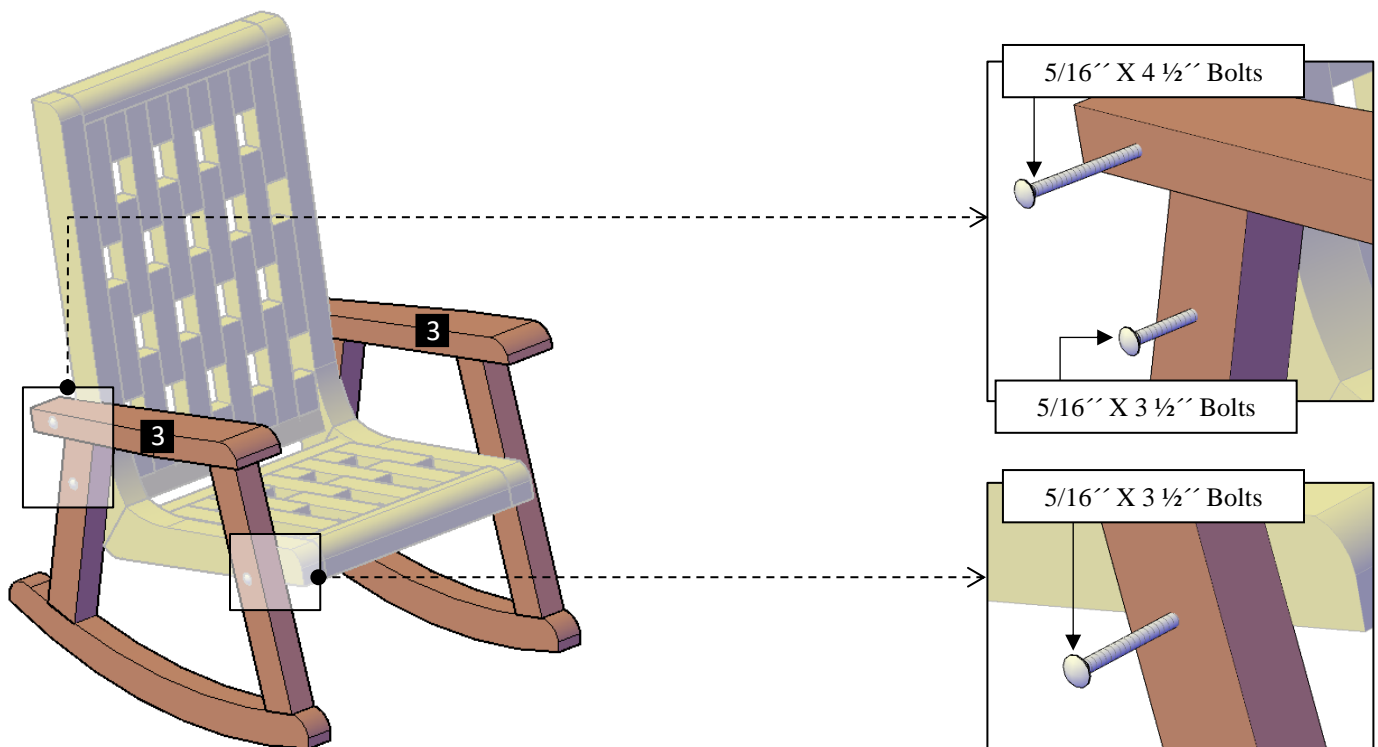



This completes the Rocking Chair assembly. Hope you enjoy your set for many decades. If you ever have a problem or a question, don't hesitate to call us (866 332 2403) or email us. We are here to support you.