



# FOREVER REDWOOD

*From the Forest, For the Forest since 1995*





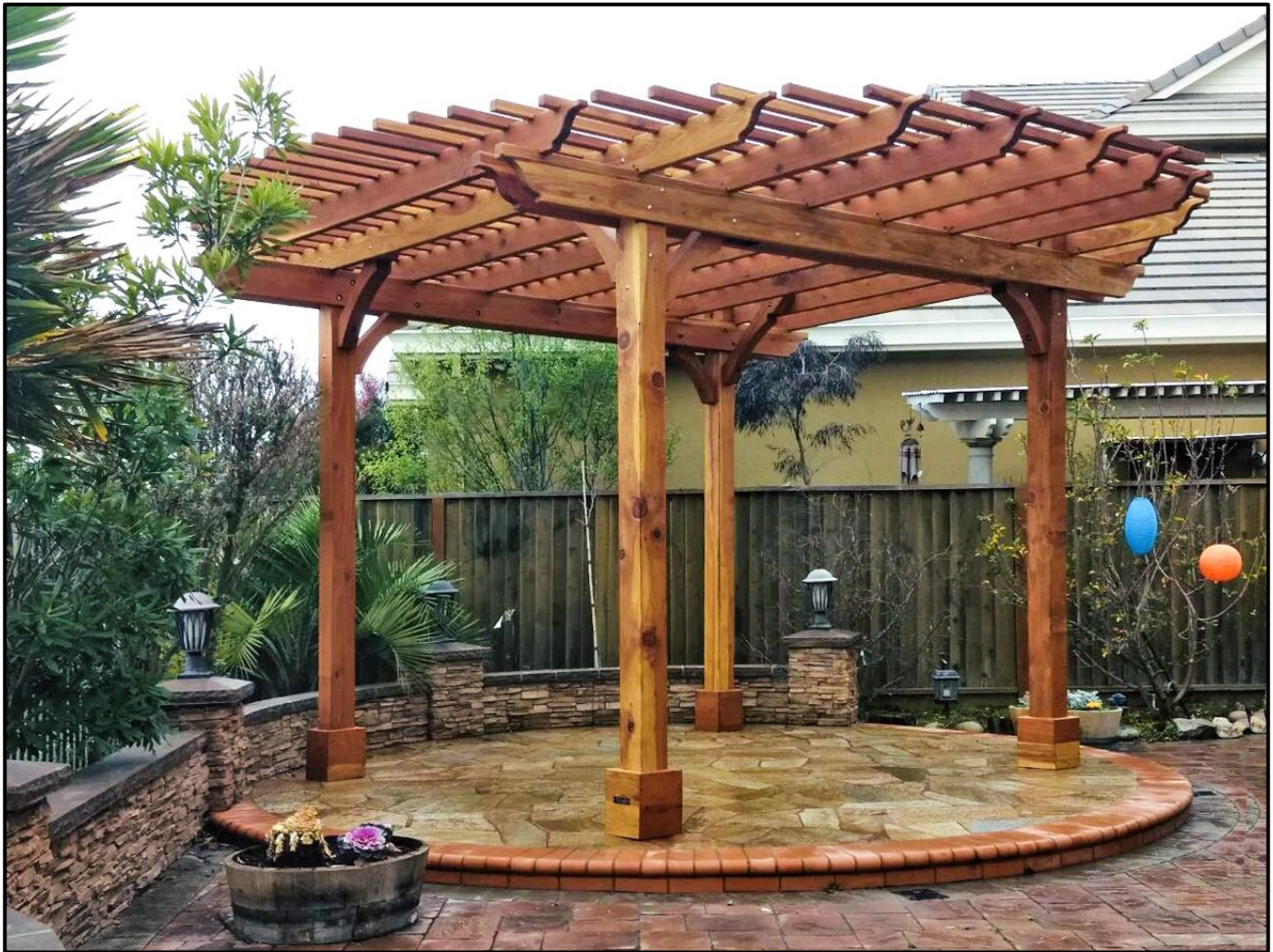

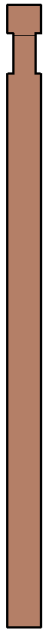
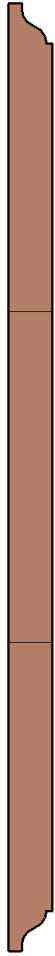
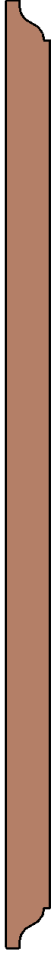
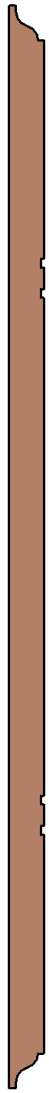

866.332.2403 (TOLL FREE); 7am – 7pm Pacific Time, Monday-Saturday

## ASSEMBLY INSTRUCTIONS FOR THE ROUND PERGOLA





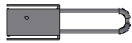





CONTENT OF BOXES

Qty.	Description	Drawing	No.
	Posts		1
	Single Supports		2
	Supports with In-Between Blocking		3
	Rafters		4
	Secondary Knee Braces		5
	Main Knee Braces		6
Will vary.	Slats		7
	Boots		8
	Standard, Gale Wind or Hurricane Anchors Bases. <b>If ordered.</b>		9
			
			Hurricane

Note: Part numbers in the Content of Boxes Table are for reference only. These do not match to the numbers marked on the parts sent.

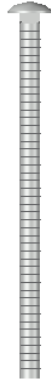
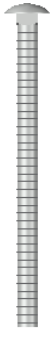

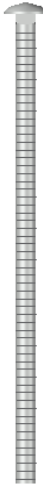
**HARDWARE LIST**

HARDWARE LIST		No.
Description	Drawing	
<p><b>1/2" X 3 1/2" Anchor Bolts</b> (To attach the anchor bases to the ground).</p>		A
<p><b>5/16" X 3" Lag Bolts</b> (To attach the anchor bases to the post).</p>		B
<p><b>3/8" X 7" Bolts</b> (To attach the supports to the posts. / To attach the supports together. / To attach the main knee braces to the supports).</p>		C
<p><b>3/8" X 6" Bolts</b> (To attach the perimeter rafters to the posts).</p>		D
<p><b>8" X 3" Deck Screws</b> (To attach the rafters and the roof lattice panels to the supports. / To attach the slats to the rafters. / To attach the boots to the posts).</p>		E
<p><b>3/8" X 9" Bolts</b> (To attach the knee braces to the posts).</p>		F
<p><b>3/8" X 5" Bolts</b> (To attach the secondary knee braces to the rafters).</p>		G

*Note: Dimensions of your hardware will vary depending on size.*

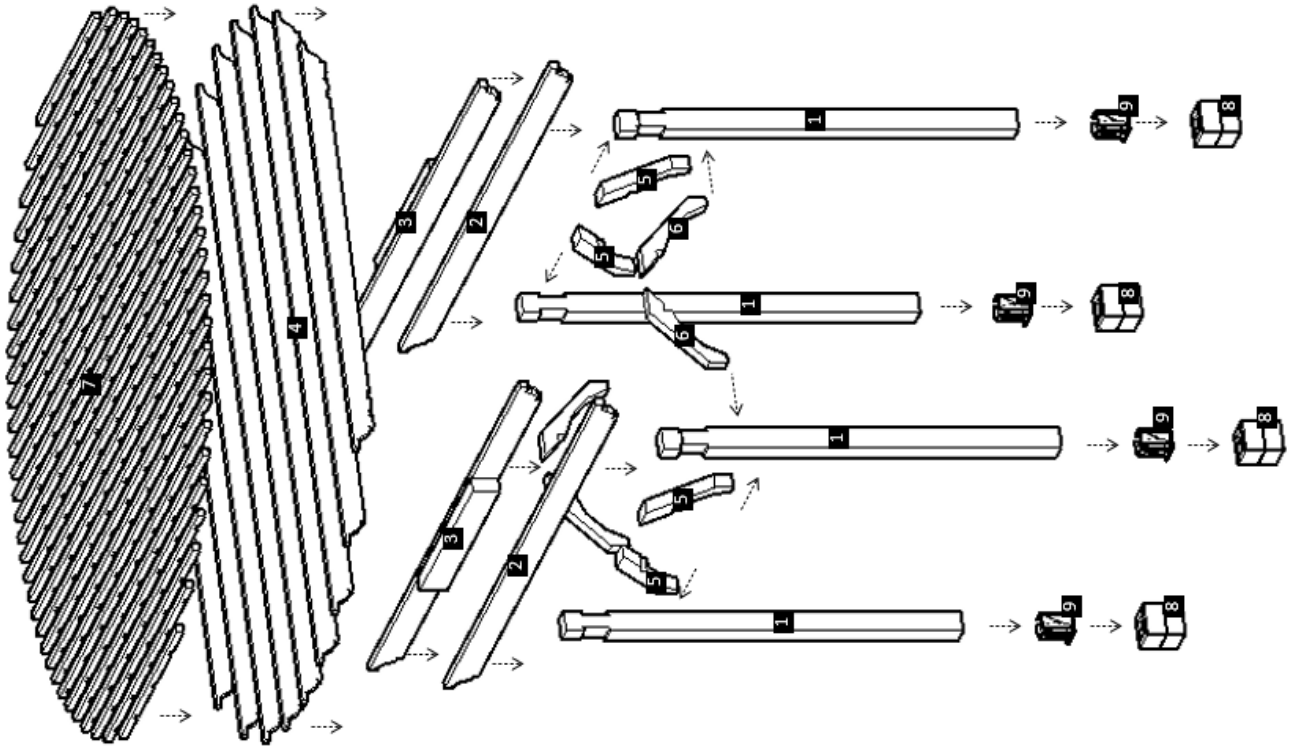

DESCRIPTION	No.
Posts	1
Single Supports	2
Supports with In-Between Blocking	3
Rafters	4
Secondary Knee Braces	5
Main Knee Braces	6
Slats	7
Boots	8
Anchors Bases	9

*Note: Part numbers in the Drawing are for reference only. These do not match to the numbers marked on the parts sent.*

**NOTE:** In order to know where the post needs to be placed, check the numbers on them. If the post is not marked, then place the single Supports on the ground to locate the markings for each post position and clearly set your bearings. (“Don’t attach yet, only place them on the ground to begin with”).

**Step 1:** Install the anchor base (9) with  $\frac{1}{2}$ ” X  $3\frac{1}{2}$ ” anchor bolts (A) or lag bolts. Please see the “How to anchor your pergola document” for all details. Set your post (1) in the saddle of the anchor bases (9). Drill a  $\phi\frac{1}{4}$ ” hole in the post prior to anchoring to facilitate the ratcheting of the hardware. After that, use a  $\frac{5}{16}$ ” X 3” lag bolts (B) to attach each post to the its respective anchor base (9).

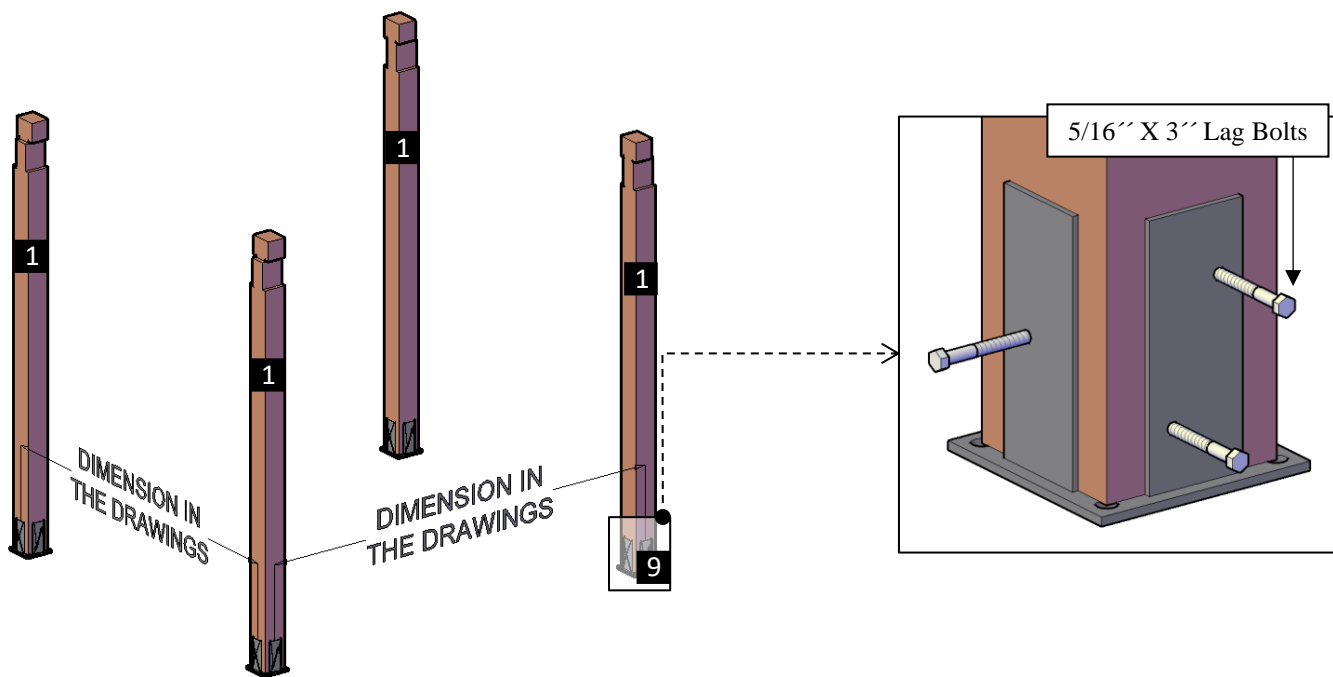

**Step 2:** First attach the single supports (2) to the posts with  $\frac{3}{8}$ ” X 7” bolts (C). Each part has a series of numbers that indicate where to attach the part with the corresponding number.

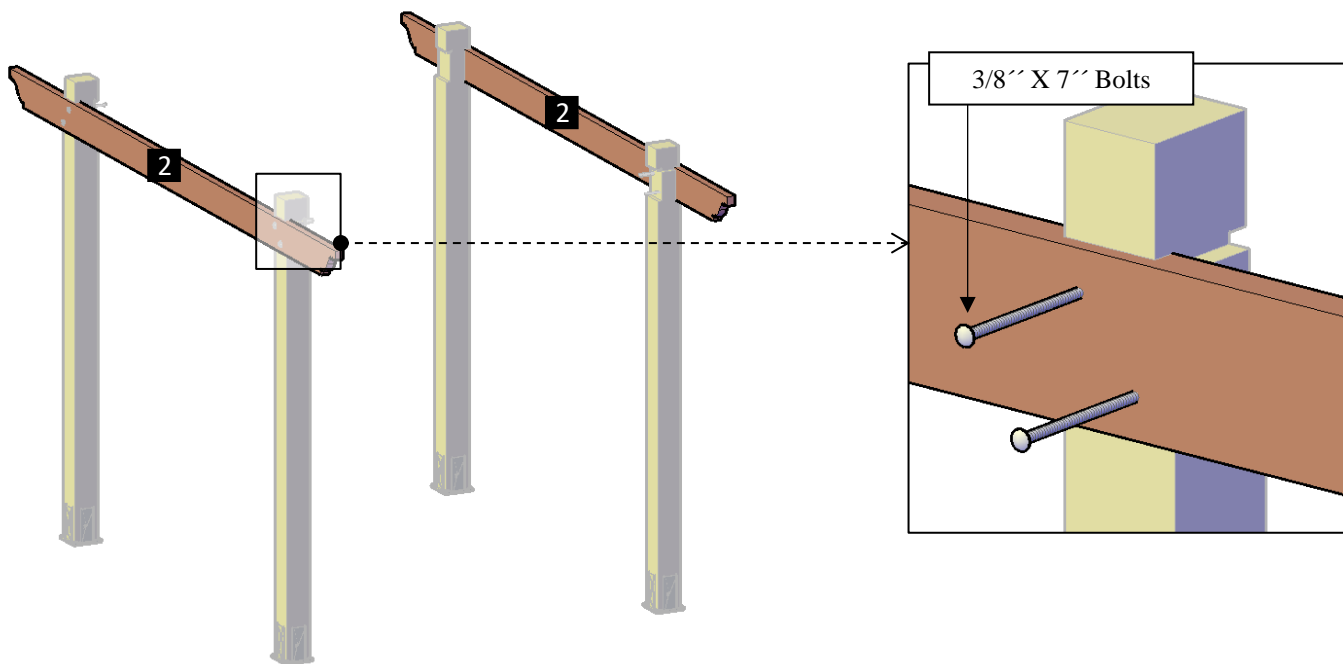

**Step 3:** Put up the supports with in-between blocking (3), into the post notches as shown and attach to the posts with the single support bolts. Each part has a series of numbers that indicate where to attach the part with the corresponding number.

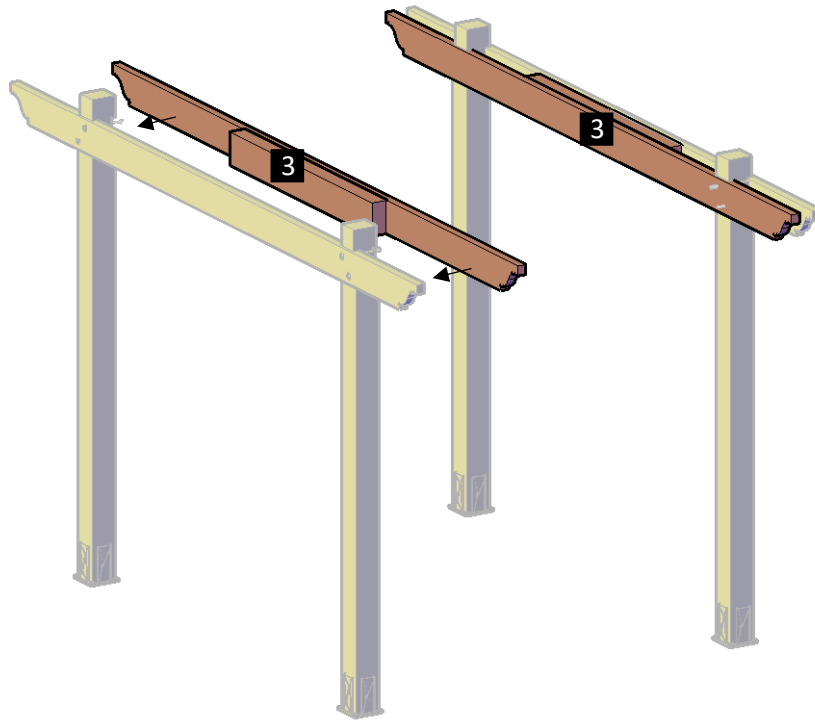

**Step 4:** Attach the single supports (2) to the supports with in-between blocking (3), use 3/8" X 7" bolts (C). The quantity of bolts depends on the length of the supports.

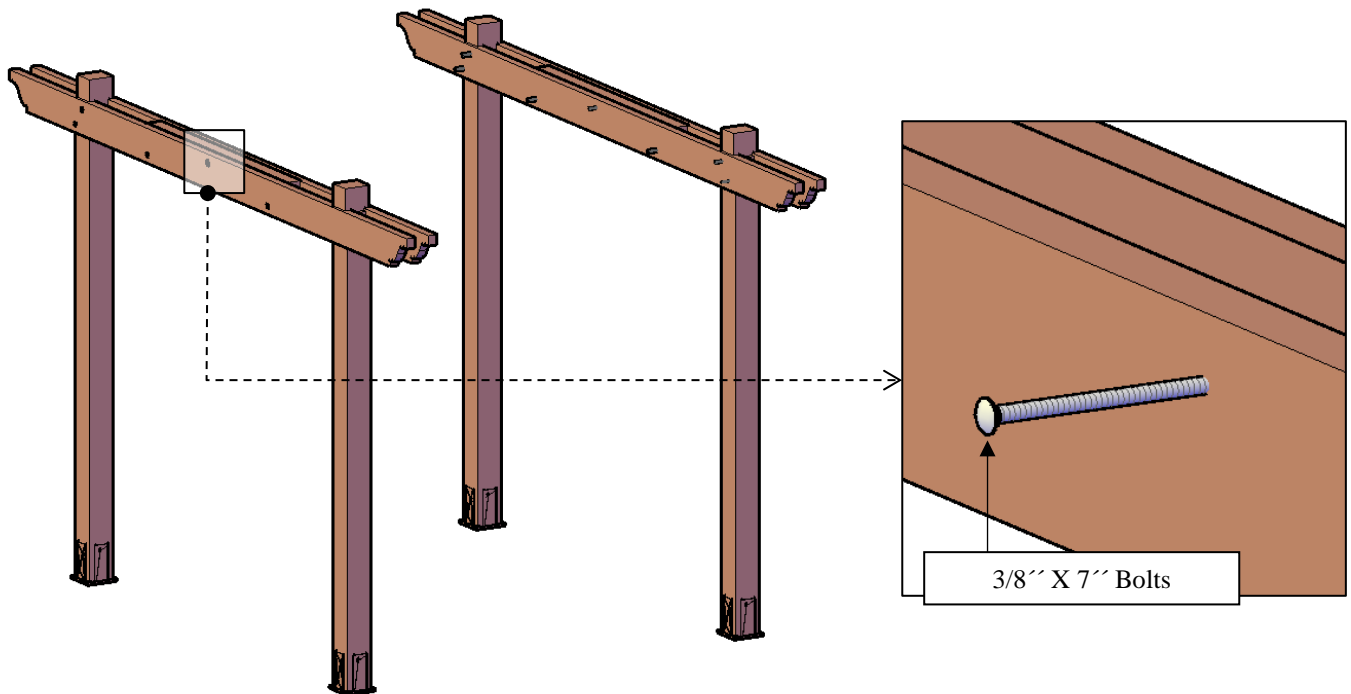

**Step 5:** Attach the perimeter rafters first (4) to the posts with 3/8" X 6" bolts (D) and to the supports with 8" x 3" deck screws (E). Each part has a series of numbers that indicate where to attach the part with the corresponding number.

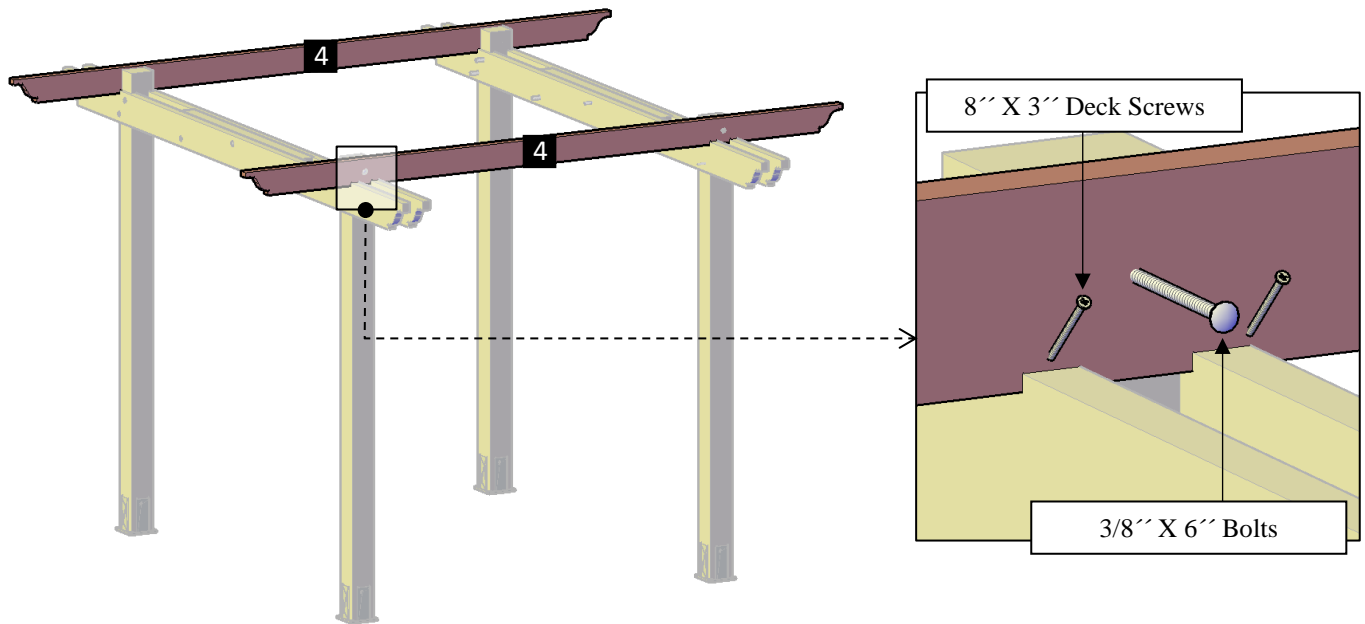

**Step 6:** Attach the main knee braces (5) to the posts with 3/8" x 9" bolts (F) and to the supports with 3/8" X 7" bolts (G). Each part has a series of numbers that indicate where to attach the part with the corresponding number.

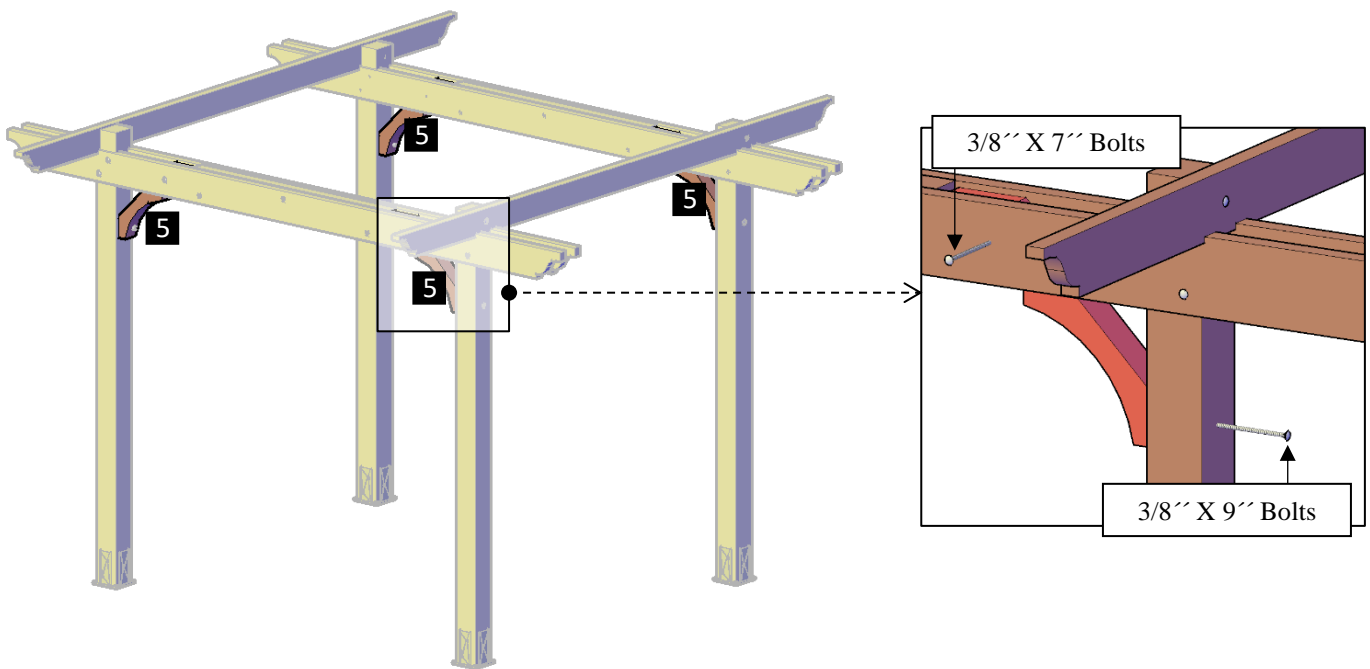

**Step 7:** Attach the secondary knee braces (6) to the posts with 3/8" x 9" bolts (F) and to the rafters with 3/8" x 5" bolts (C). Each part has a series of numbers that indicate where to attach the part with the corresponding number.

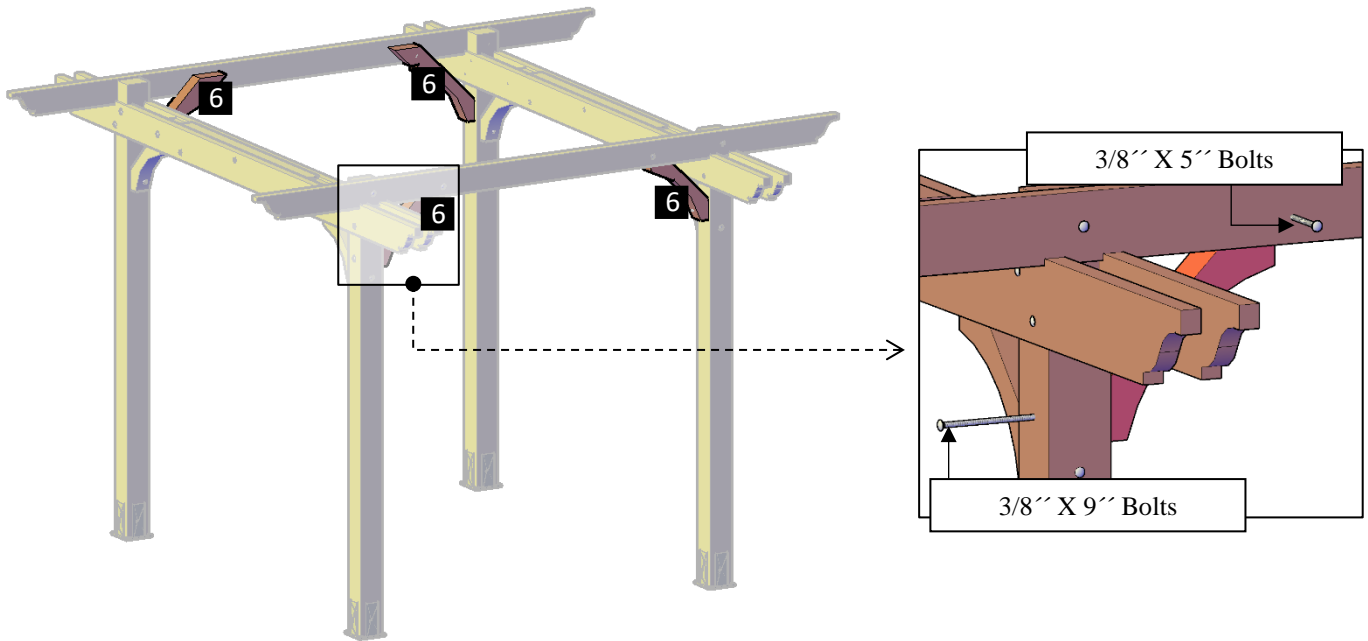

**Step 8:** Use 8" x 3" deck screws (E) to attach the rest of the rafters (4) to the supports. Each part has a series of numbers that indicate where to attach the part with the corresponding number.

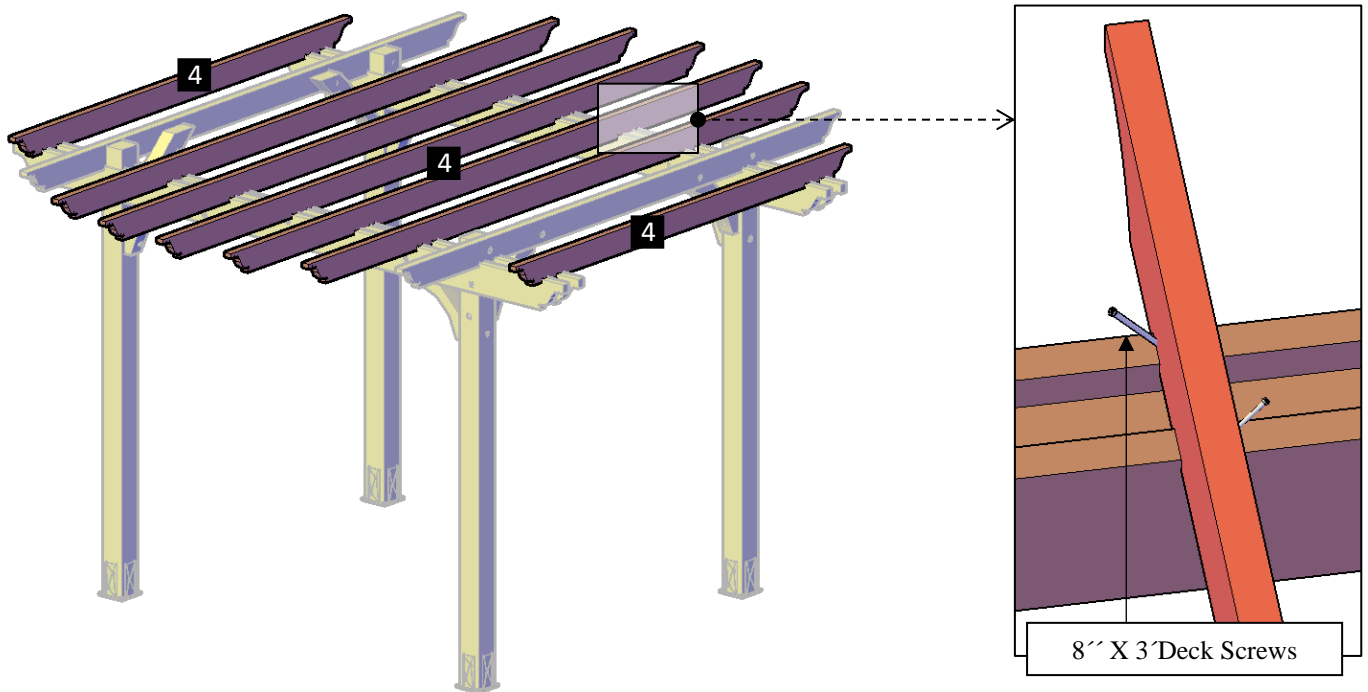



**Step 9:** Use 8'' x 3'' deck screws (E) to attach each slats (7) to the rafters. Each part has a series of numbers that indicate where to attach the part with the corresponding number.

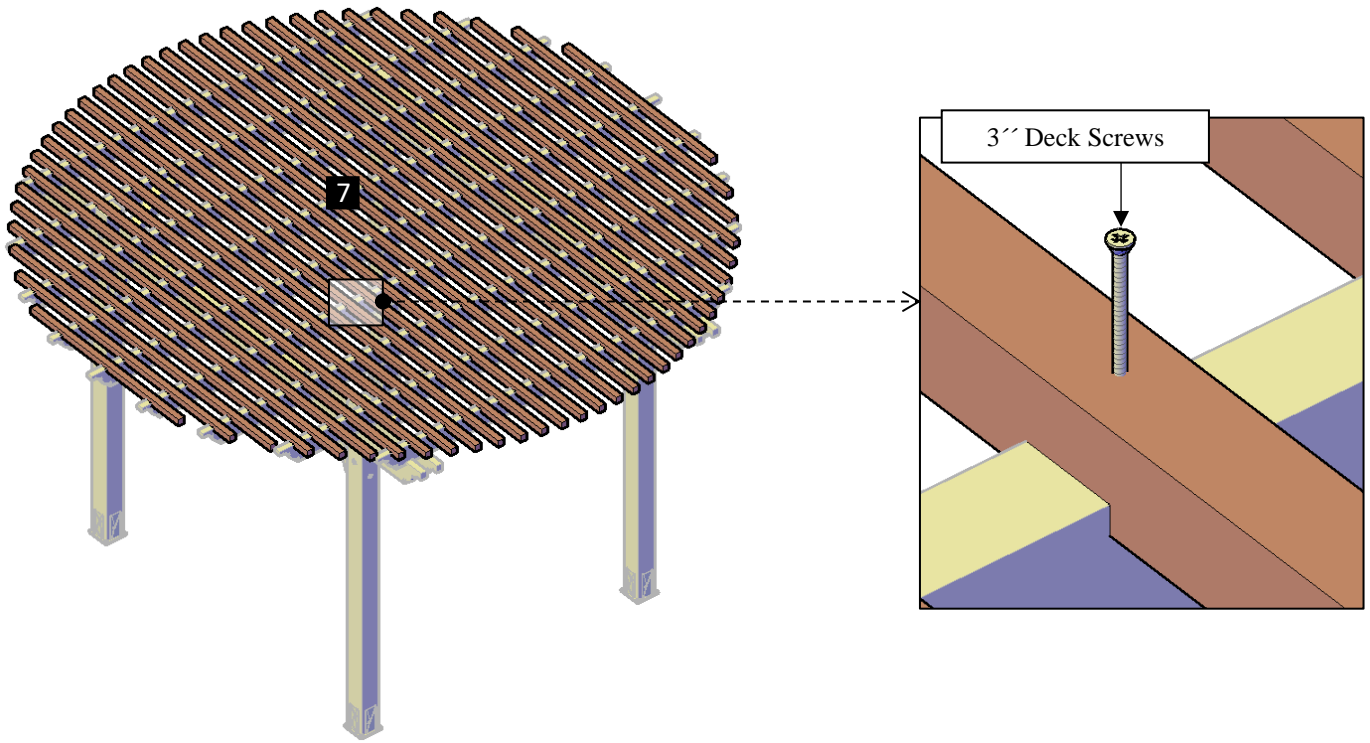

**Step 10:** Finally, attach the boots (8) to the posts with 8'' x 3'' deck screws (E). Each part has a series of numbers that indicate where to attach the part with the corresponding number.

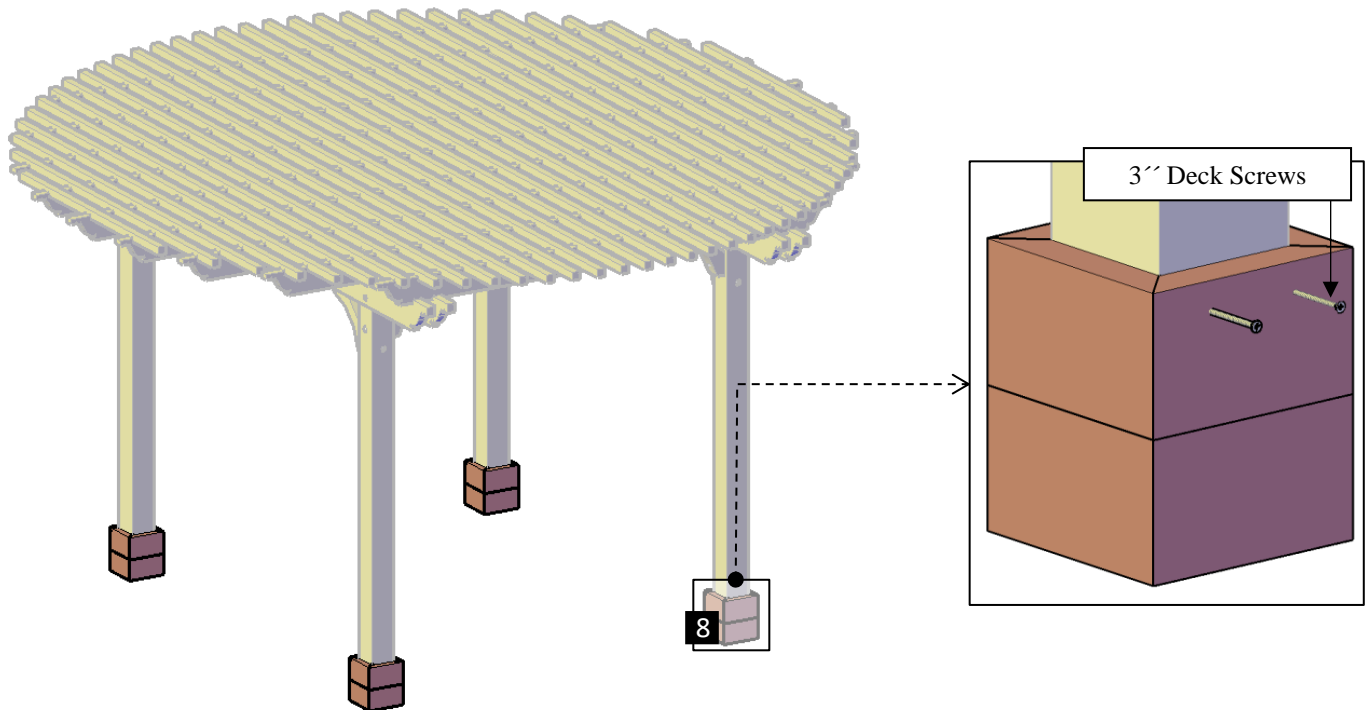



*This completes the Pergola assembly. Hope you enjoy your set for many decades. If you ever have a problem or a question, don't hesitate to call us (866 332 2403) or email us. We are here to support you.*