



# FOREVER REDWOOD













*From the Forest, For the Forest since 1995*

866.332.2403 (TOLL FREE); 7am – 7pm Pacific Time, Monday-Saturday

## ASSEMBLY INSTRUCTIONS FOR THE TRADITIONAL WOODEN GARDEN PERGOLA







CONTENT OF BOXES			
Qty.	Description	Drawing	No.
	Posts		1
	Single Supports		2
	Supports with In-Between Blocking		3
	Rafters		4
	Main Knee Braces		5
	Secondary Knee Braces		6
Will vary	Slats-A		7
	Slats-B		8
	Boots <b>If ordered</b>		9
	Standard, Gale Wind or Hurricane Anchors Bases. <b>If ordered</b>		10
			
			Hurricane

*Note: Part numbers in the Content of Boxes Table are for reference only. These do not match to the numbers marked on the parts sent.*

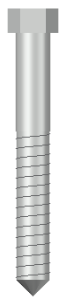
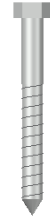
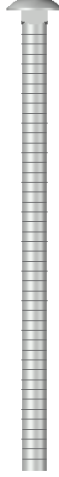
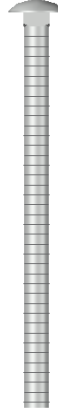
## HARDWARE LIST

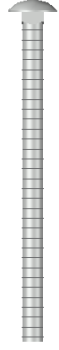
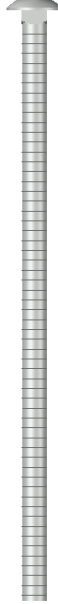
Description	Drawing	No.
<p>½" X 4" Anchor Bolts (To attach the anchor bases to the ground).</p>		A
<p>½" X 4" Lag Bolts (To attach the anchor bases to the ground).</p>		B
<p>5/16" X 3" Lag Bolts (To attach the anchor bases to the posts).</p>		C
<p>3/8" X 7" Bolts (To attach the supports to the posts. / To attach the supports together. / To attach the main knee braces to the supports).</p>		D
<p>3/8" X 6" Bolts (To attach the rafters to the posts).</p>		E
<p>3" Deck Screws (To attach the rafters to the supports. / To attach the slats to the rafters. / To attach the boots to the posts).</p>		F
<p>5/16" X 5" Bolts (To attach the secondary knee braces to the rafter).</p>		G
<p>3/8" X 9" Bolts (To attach the knee braces to the posts).</p>		H

*Note: Dimensions of your hardware will vary depending on size.*

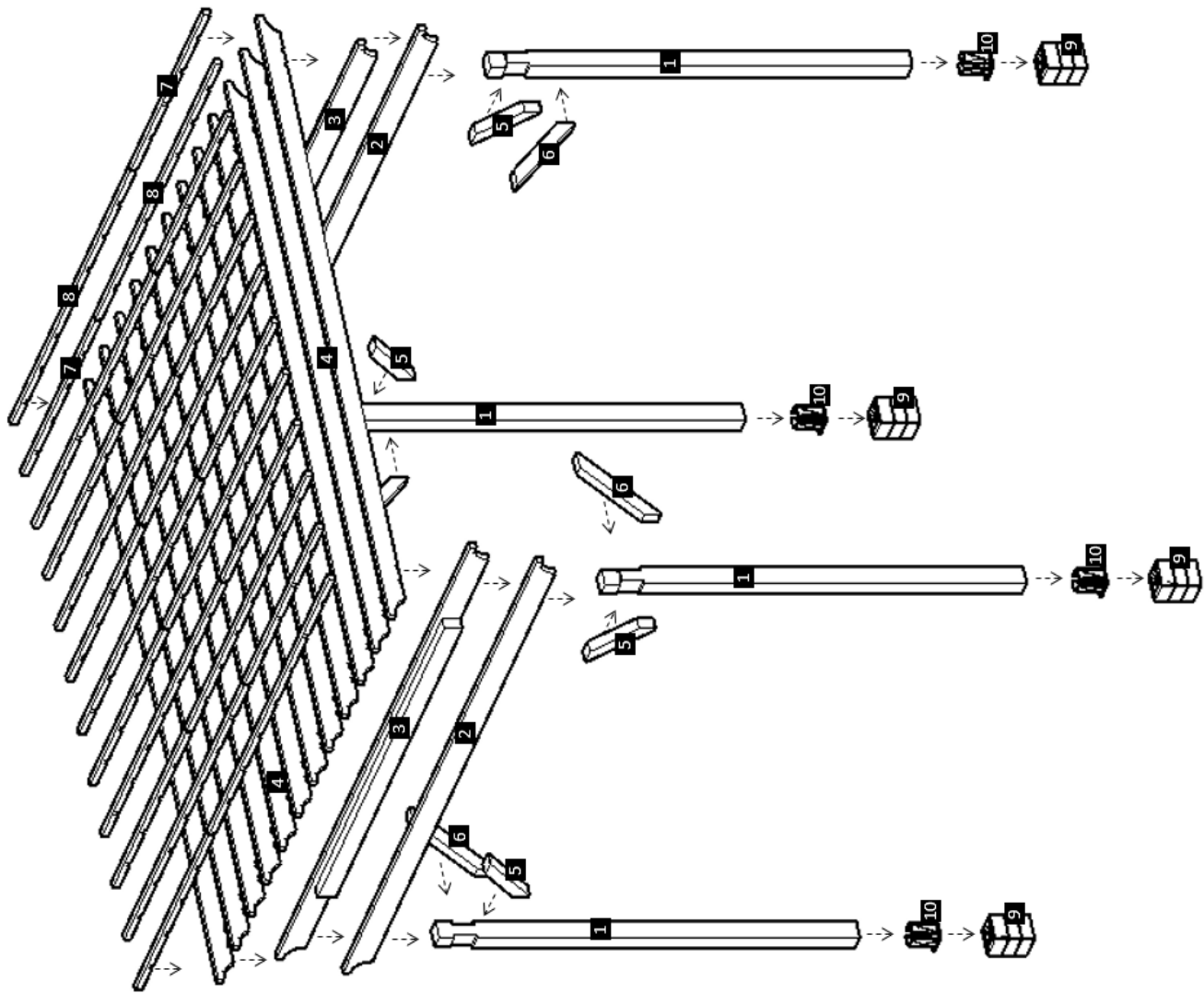

DESCRIPTION	No.
Posts	1
Single Supports	2
Supports with In-Between Blocking	3
Rafters	4
Main Knee Braces	5
Secondary Knee Braces	6
Slats-A	7
Slats-B	8
Boots	9
Anchor Bases	10

*Note: Part numbers in the Drawing are for reference only. These do not match to the numbers marked on the parts sent.*

**NOTE:** In order to know where the post needs to be placed, check the numbers on them. If the post is not marked, then place the single Supports on the ground to locate the markings for each post position and clearly set your bearings. (“Don’t attach yet, only place them on the ground to begin with”).

**Step 1:** Install the anchor bases (**10**) with  $\frac{1}{2}$ " X 4" anchor bolts (**A**) (for concrete deck) or  $\frac{1}{2}$ " x 4" lag bolts (**B**) (for wood deck). Please see the “How to anchor your pergola document” for all details. Set your post (**1**) in the saddle of the anchor bases. Drill a  $\phi$   $\frac{1}{4}$ " hole in the post prior to anchoring to facilitate the ratcheting of the hardware. After that, use  $\frac{5}{16}$ " X 3" lag bolts (**C**) to attach each post to its respective anchor base.

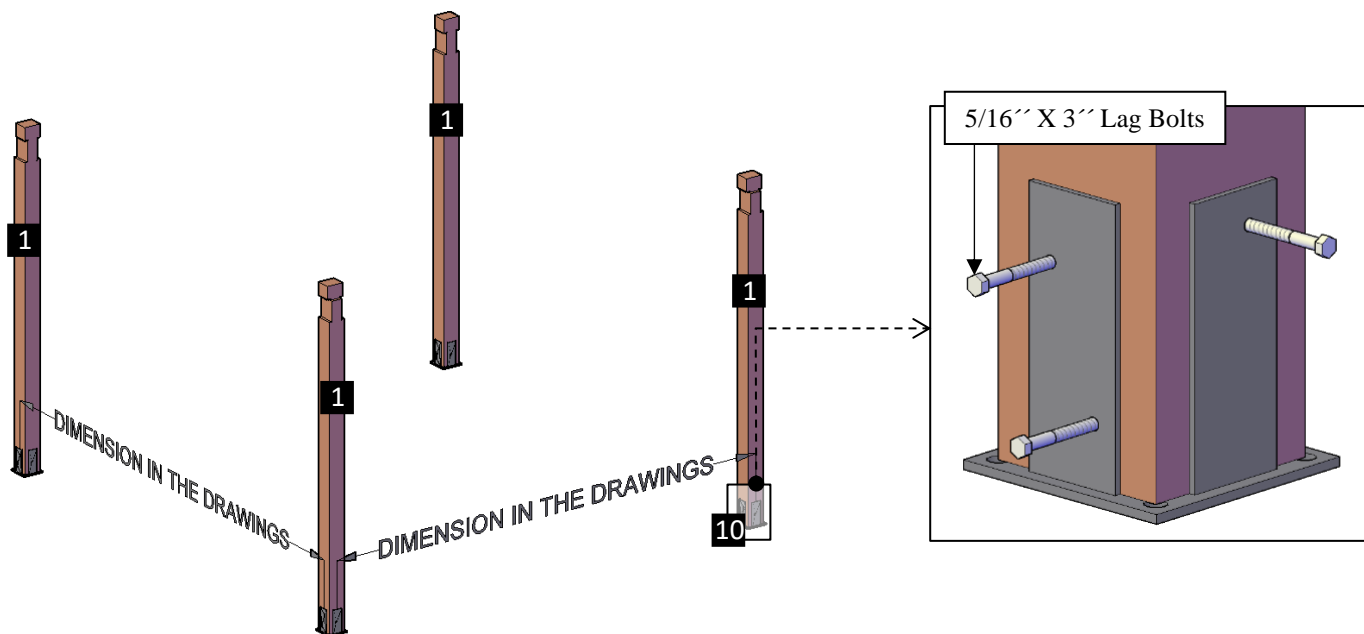

**Step 2:** Use  $\frac{3}{8}$ " X 7" bolts (**D**) to attach the single supports (**2**) to the posts. Each part has a series of numbers that indicate where to attach the part with the corresponding number.

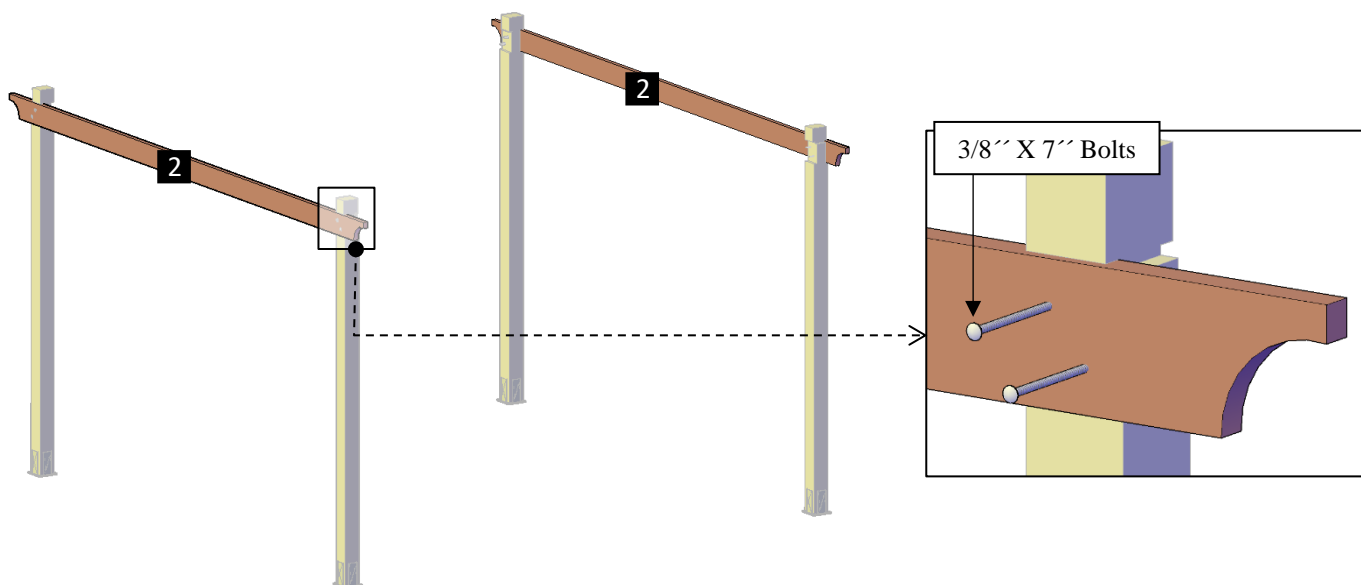

**Step 3:** Place the supports with in-between blocking (3), into the post notches as shown and attach to the post with the single support bolts. Each part has a series of numbers that indicate where to attach the part with the corresponding number.



**Step 4:** Attach the single supports to the supports with in-between blocking (3), use 3/8" X 7" bolts (D).

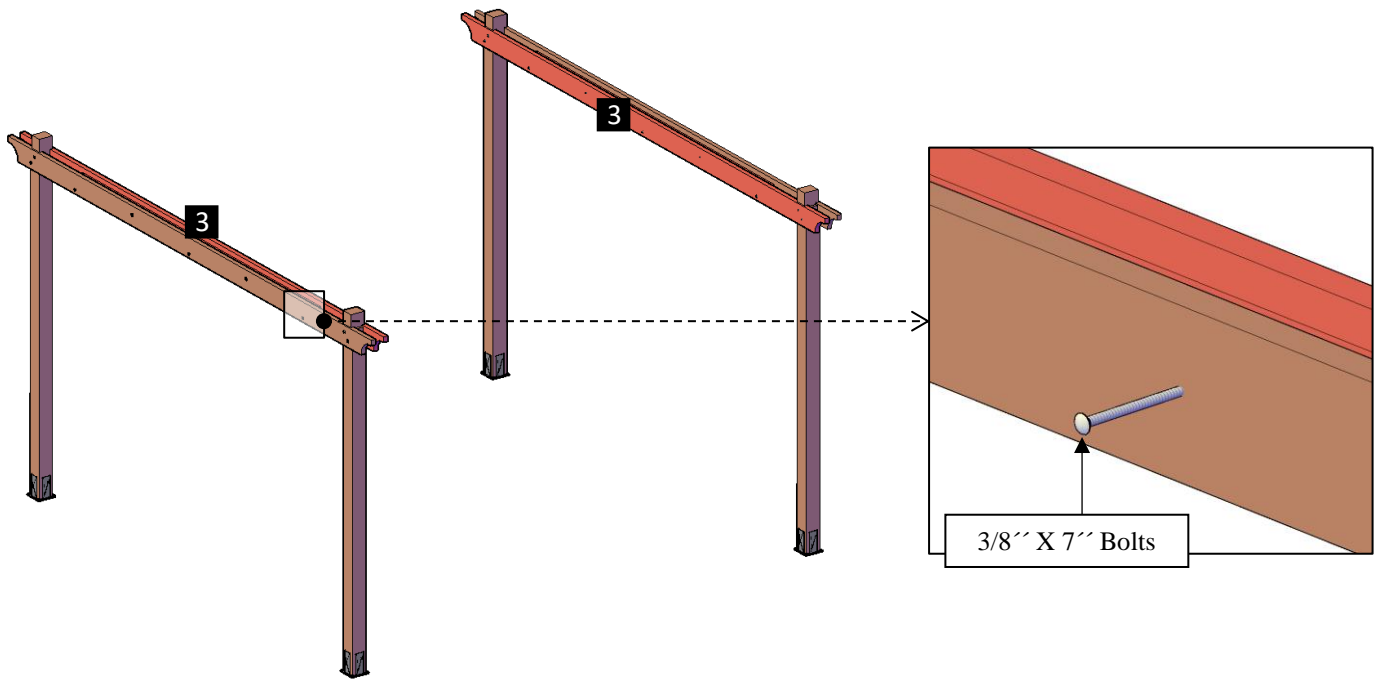

**Step 5:** Use 3/8" x 6" bolts (E) to attach the perimeter rafters (4) to the posts and 3" deck screws (F) to attach to the supports. Each part has a series of numbers that indicate where to attach the part with the corresponding number.

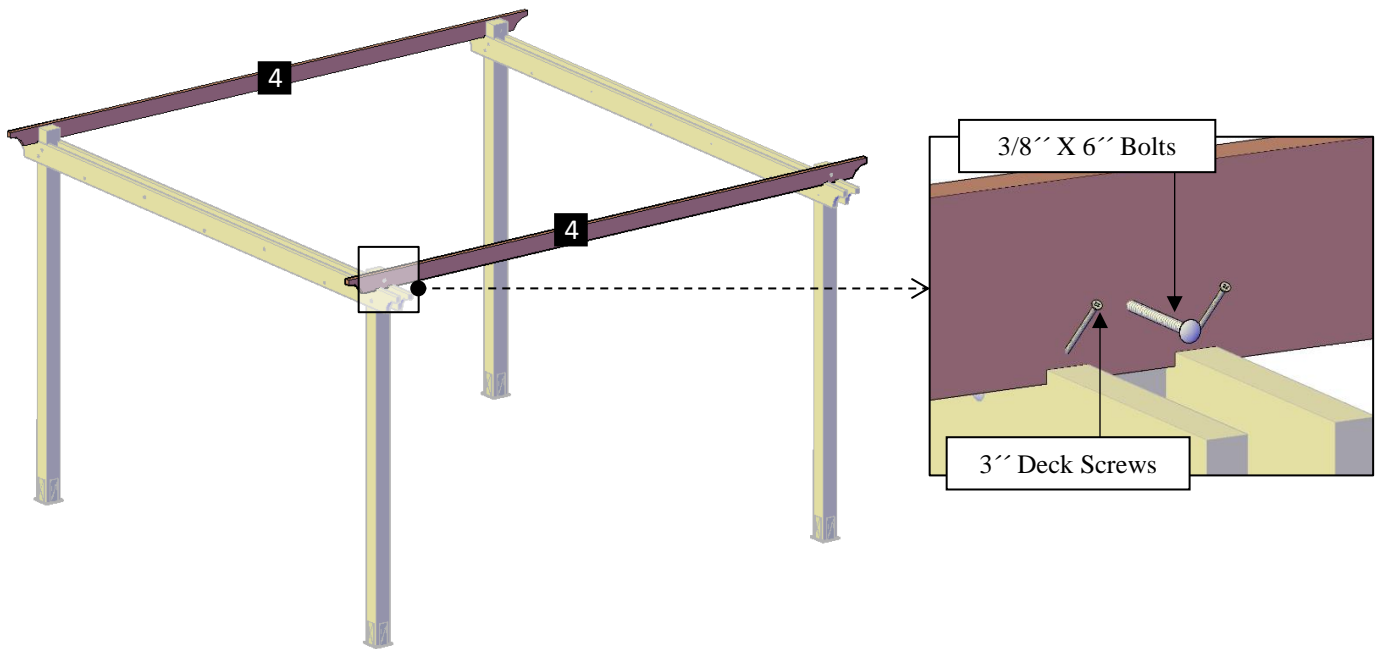

**Step 6:** Attach the main knee braces (5) to the supports with 3/8" x 7" bolts (D) and to the posts with 3/8" x 9" bolts (H). Each part has a series of numbers that indicate where to attach the part with the corresponding number.

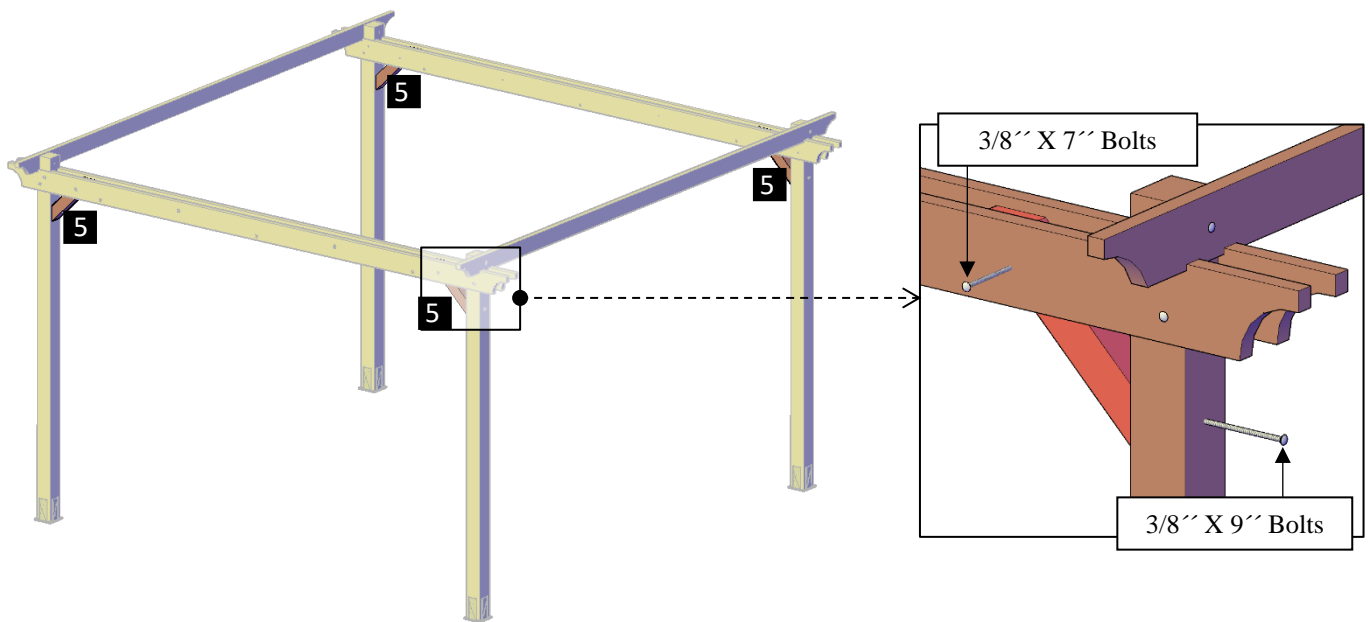

**Step 7:** Attach the Secondary knee braces (6) to the rafters with 5/16" x 5" bolts (G) and to the posts with 3/8" x 9" bolts (H). Each part has a series of numbers that indicate where to attach the part with the corresponding number.

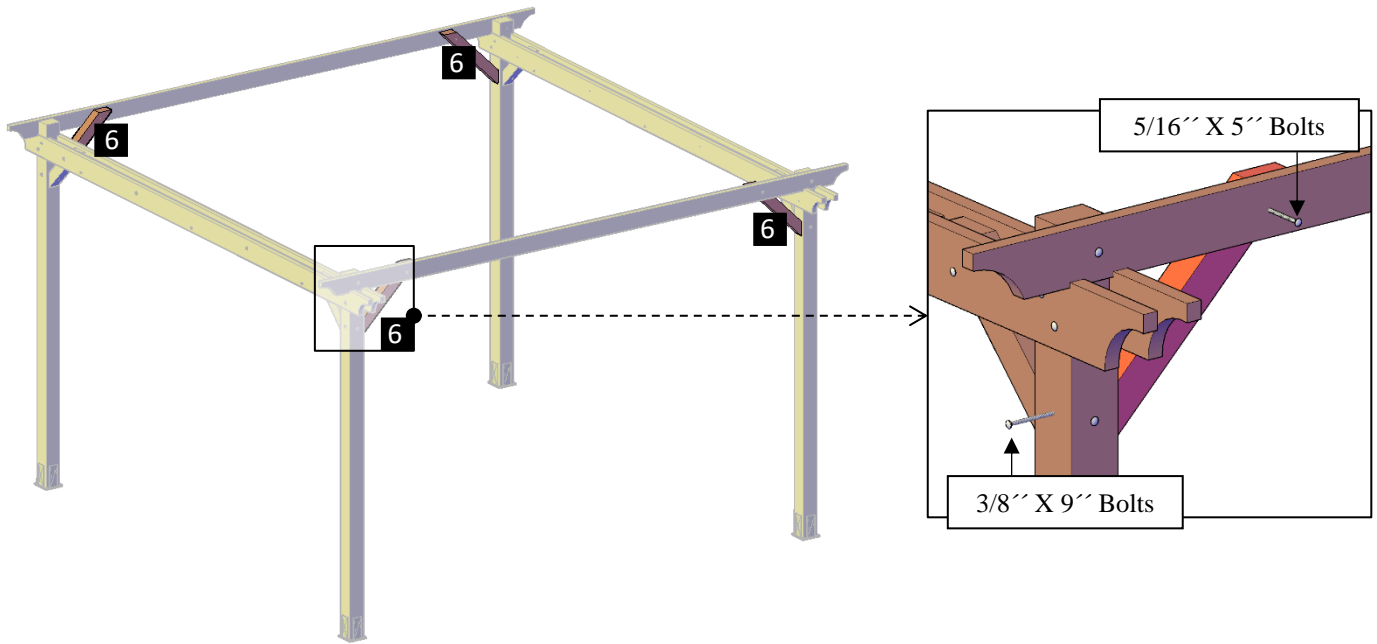

**Step 8:** Use 8" x 3" deck screws (F) to attach the central rafters (4) to the supports. Each part has a series of numbers that indicate where to attach the part with the corresponding number.

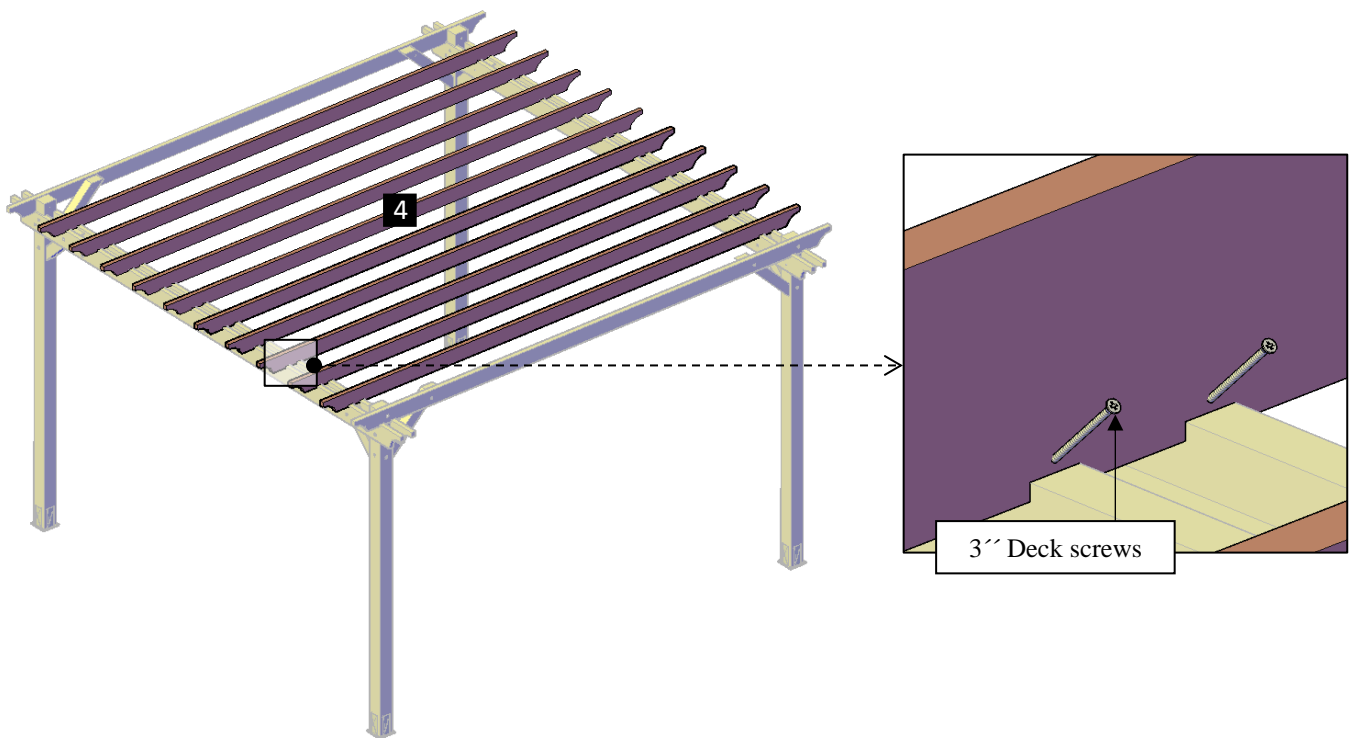



**Step 9:** Attach the Slats A&B (7,8) to the rafters with 3" x 3" deck screws (F). Each part has a series of numbers that indicate where to attach the part with the corresponding number.

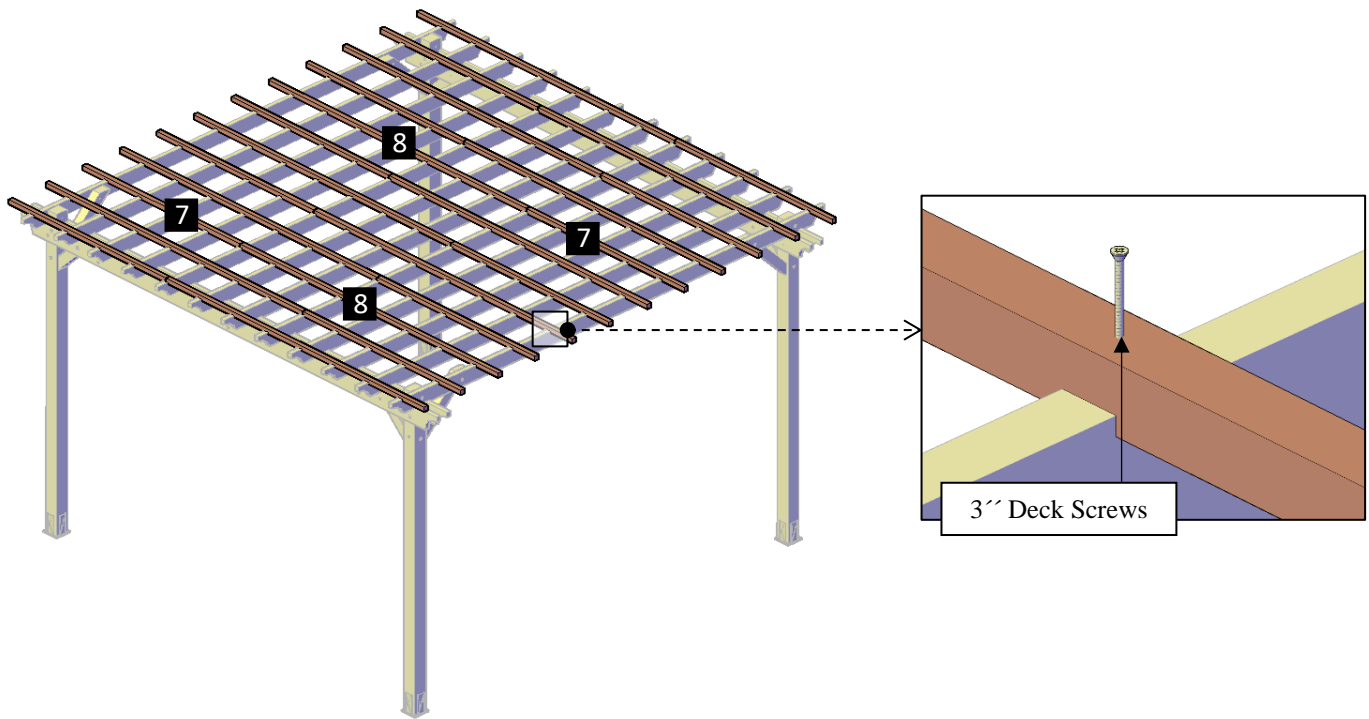

**Step 10:** Finally, attach the boots (9) to the posts with 3" x 3" deck screws (F). Each part has a series of numbers that indicate where to attach the part with the corresponding number.

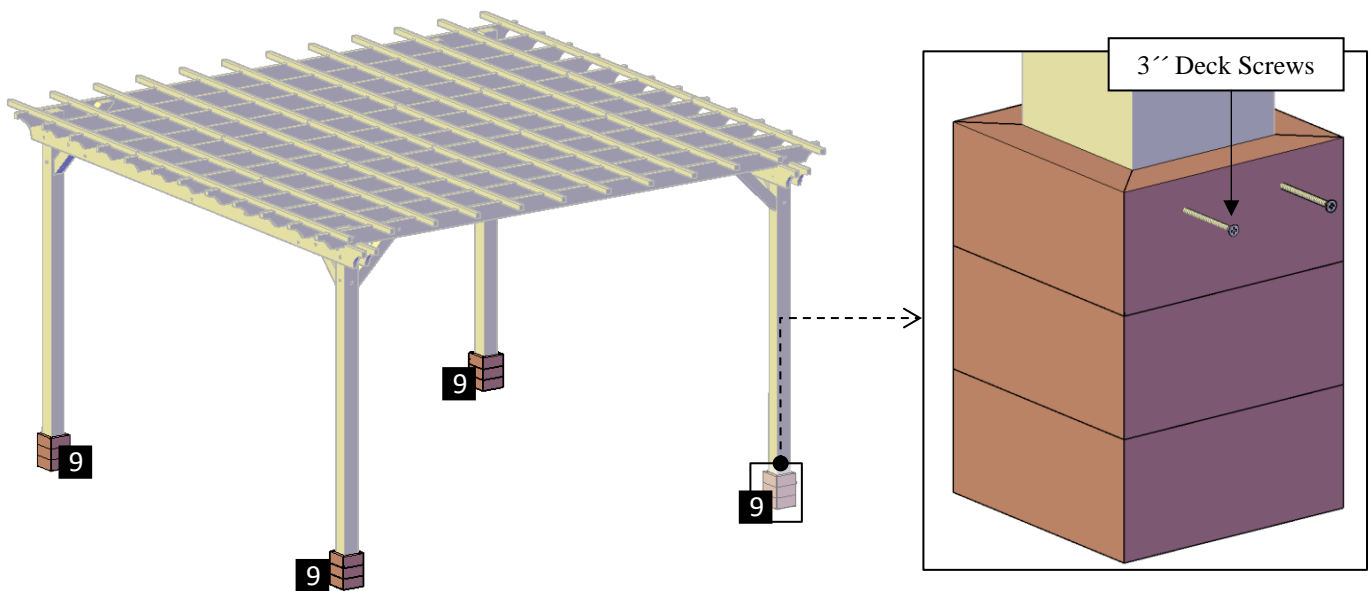



*This completes the Pergola assembly. Hope you enjoy your set for many decades. If you ever have a problem or a question, don't hesitate to call us (866 332 2403) or email us. We are here to support you.*