

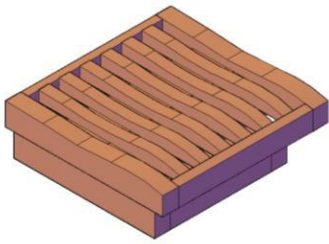

Assembly instructions for: **VERA'S SWIVEL BAR STOOLS**

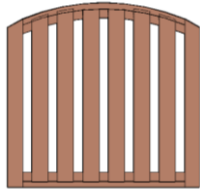
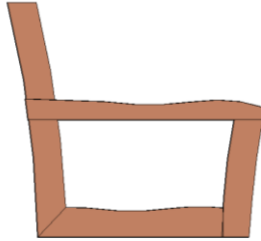
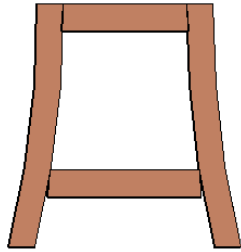
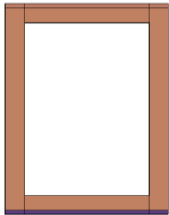

CONTENT OF BOXES

<u>Quantity</u>	<u>Description</u>	<u>Drawing</u>
18	Carriage bolts 3 ½" x 5/16", Washers & Nuts	
2	Carriage bolts 4 ½" x 5/16", Washers & Nuts	
1	Seat with swivel base	
1	Backrest	
2	Arm assemblies left & right	
2	Leg assemblies left & right	
1	Leg support	
2	Supports	

ASSEMBLY INSTRUCTIONS

Thank you for purchasing Forever Redwood patio furniture. Forever Redwood is built by Old-Growth Again Restoration Forestry (OGA). OGA is dedicated to restoration forestry. Sales of patio furniture finance our restoration work in California redwood forestlands.

Tools required: ½-inch ratchet and a mallet or small hammer.

Your furniture was fully assembled in the shop prior to being dismantled for shipping. All the parts fit. The parts that go together have the same numbers written next to the predrilled holes they attach to. Please take the time to align the parts with the numbers. If you are forcing a bolt in, the part may be turned around or not aligned properly. Tap the bolt all the way into the wood to set it, then add a washer and lightly tighten. Don't over tighten or you will crush the redwood

STEP 1:

Attach the arm assembly left to seat, with two bolts (3 ½" x 5/16"), washers & nuts (Match up the numbers to attach the two parts together). Tap the bolt all the way into the wood to set it. Then add a washer and nut and lightly tighten. Repeat this step with the other side

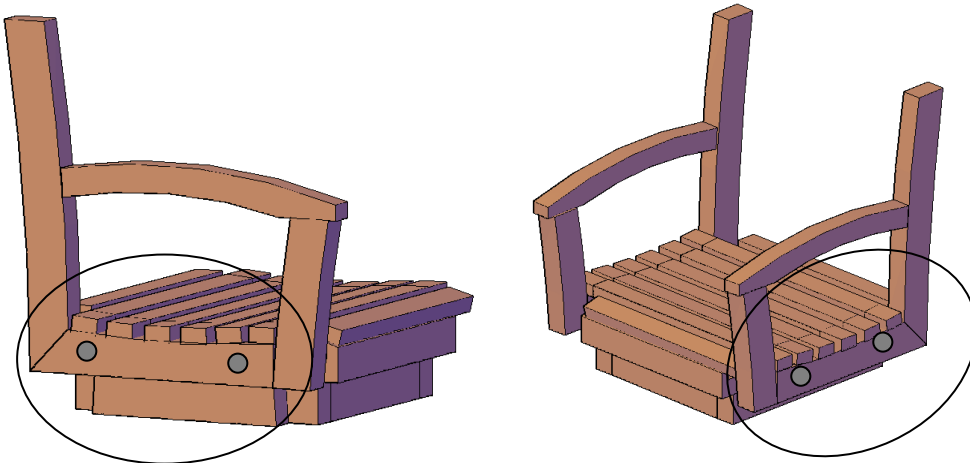

STEP 2:

Attach the backrest to arm assembly left, with two bolts (3 ½" x 5/16"), washers & nuts (Match up the numbers to attach the two parts together). Tap the bolt all the way into the wood to set it. Then add a washer and nut and lightly tighten. Repeat this step with the other side.

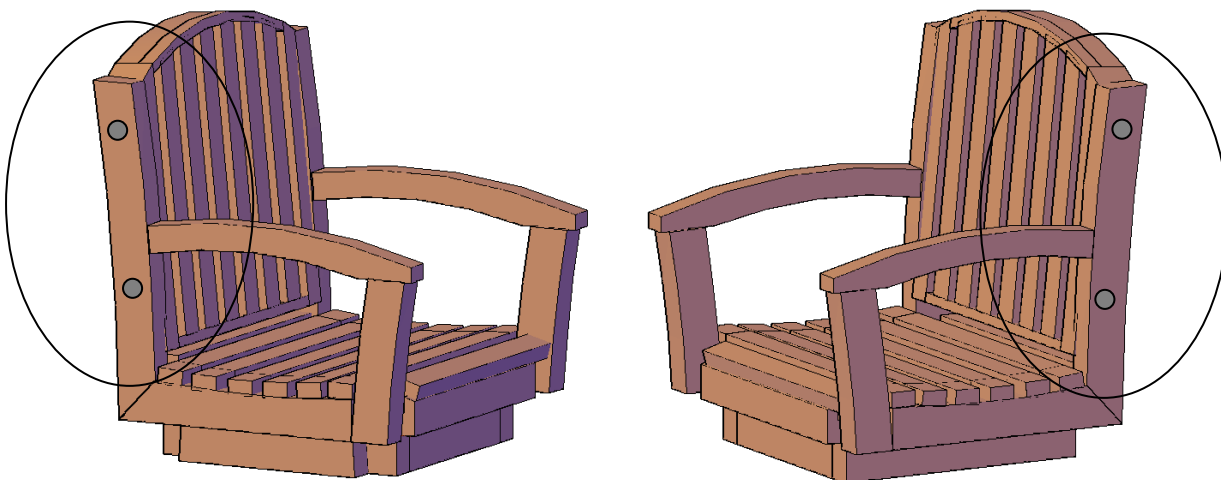

STEP 3: Attach the seat to the leg assembly left, with two bolts (3 1/2" x 5/16"), washers & nuts (Match up the numbers to attach the two parts together). Tap the bolt all the way into the wood to set it. Then add a washer and nut and lightly tighten. Repeat this step with the other side

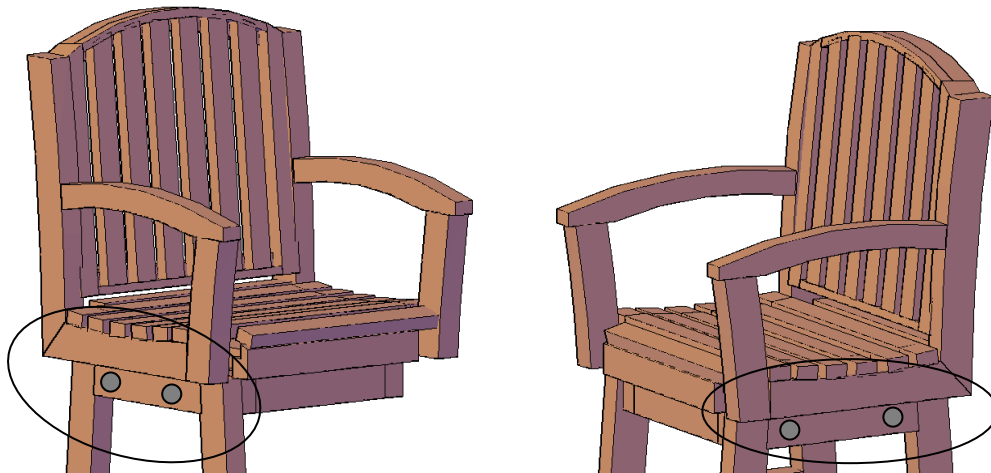

STEP 4: Attach the leg support to the leg assembly left, with two bolts (3 1/2" x 5/16"), washers & nuts (Match up the numbers to attach the two parts together). Tap the bolt all the way into the wood to set it. Then add a washer and nut and lightly tighten. Repeat this step with the other side.

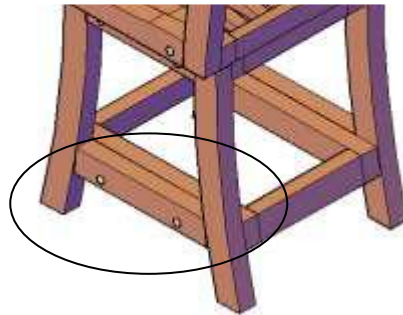

STEP 5: Attach the support to the leg assembly left and seat, with two bolts, washers & nuts (Match up the numbers to attach the two parts together). Tap the bolt all the way into the wood to set it. Then add a washer and nut and lightly tighten. Repeat this step with the other side.

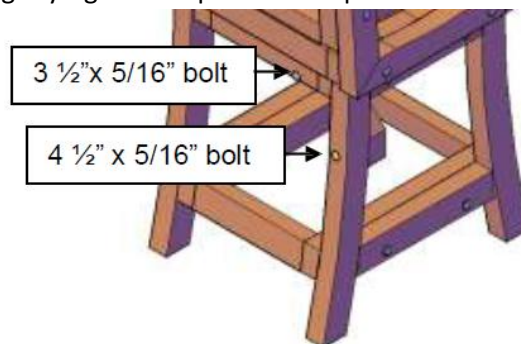

Thank you. If you have any questions, please call or email us.