



FOREVER REDWOOD

From the Forest, For the Forest since 1995

866.332.2403 (TOLL FREE); 7am – 7pm Pacific Time, Monday-Saturday

LA GRANGE REDWOOD LOUNGER



CONTENT

I. DESCRIPTION	2
II. SPECIFICATIONS	3
A. Dimensions & Drawings	3
B. Snack Trays	4
C. Lounger Height.....	4
D. Lounger Wheels	5
E. Custom Cushions Sections	6
F. Custom Cushions.....	7
G. Finish Options	8
III. ASSEMBLY & CARE.....	11
IV. MATERIALS	12
V. WARRANTY	13
VI. SHIPPING.....	13

I. DESCRIPTION

Each board, wheel, plank, and base on this Solid Redwood Lounger is handmade by us, in our CA studios. We use the best quality timber available in the United States, and build your lounger thick so it can withstand lots of pressure, and all types of inclement weather for decades to come. You can also customize your new La Grange Redwood Lounger for a stained coat and finish, and even add a snack tray, or padded cushion for extra comfort.

- Choose from single, honeymoon, or double width sizes.
- La Grange Lounger Includes extra-large armrests and 5 backrest settings from flat to a comfortable upright reading position.
- In More Options select hand-made cushions, snack tray configuration, lounger height and whether to add wheels.
- All our loungers use only stainless steel bolts that will never rust.
- **Fast, easy assembly.** Instructions provided with shipment and also available online.
- Our authentic California Redwood exceeds FSC certification standards for sustainability.
- See more handcrafted [wooden loungers](#).

Online ordering is easier than ever, and we can build your La Grange Redwood Lounger the way you like through our versatile customization options. You can also make special order requests, and we'll do our best to accommodate your needs when available. Shipping is available in the United States (not Alaska, Hawaii, or territories), and we have a number of great warranty options available on select products as well. Contact us here to learn more.

II. SPECIFICATIONS

A. Dimensions & Drawings

Standard

	L1	L2	L3	W1	W2	H1	H2-Armrest Height	Approx. Weight
Single	74"	29"	45"	28"	39-1/2"	13", 15-1/2", 18"	20-3/8", 22-7/8", 25-3/8"	90 lbs.
Honeymoon	74"	29"	45"	38"	49-1/2"	13", 15-1/2", 18"	20-3/8", 22-7/8", 25-3/8"	110 lbs.
Double	74"	29"	45"	47"	58-1/2"	13", 15-1/2", 18"	20-3/8", 22-7/8", 25-3/8"	135 lbs.

Extra Large

	L1	L2	L3	W1	W2	H1	H2-Armrest Height
Single	80"	32"	48"	28"	39-1/2"	13", 15-1/2", 18"	20-3/8", 22-7/8", 25-3/8"
Honeymoon	80"	32"	48"	38"	49-1/2"	13", 15-1/2", 18"	20-3/8", 22-7/8", 25-3/8"
Double	80"	32"	48"	47"	58-1/2"	13", 15-1/2", 18"	20-3/8", 22-7/8", 25-3/8"

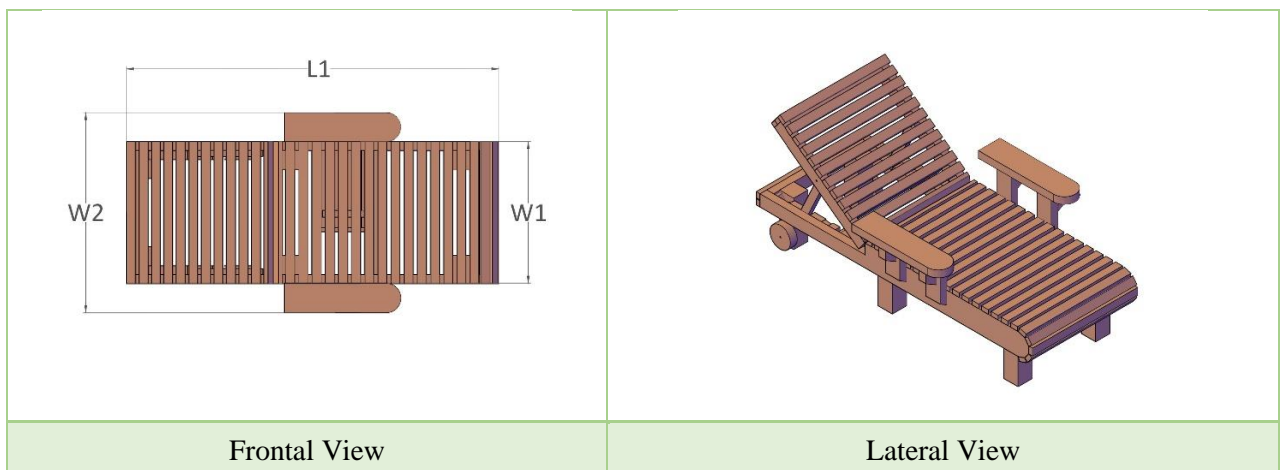
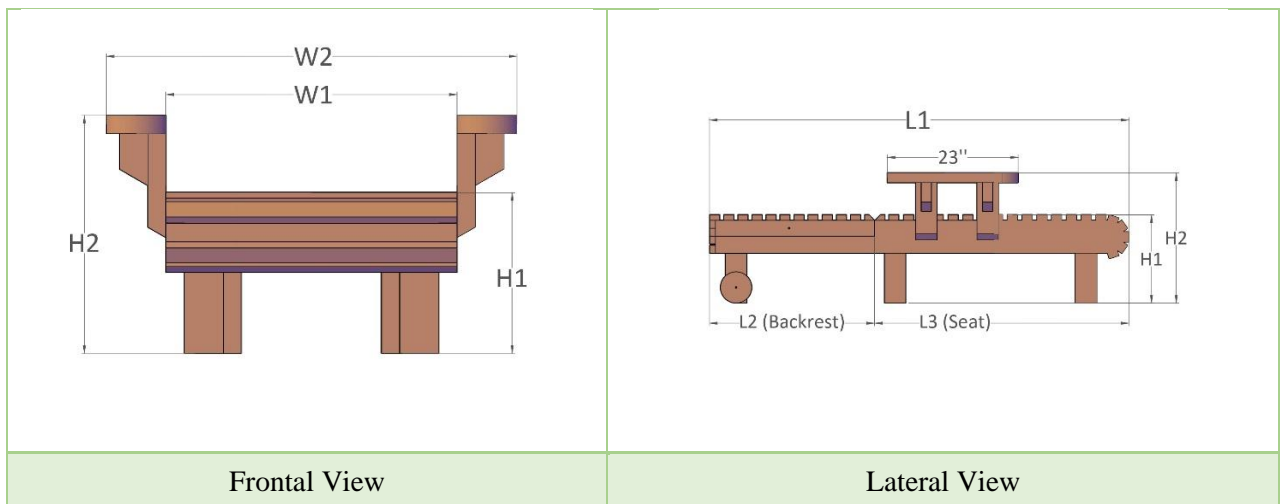

Backrest Settings: All of our loungers have 5 backrest settings, from flat (parallel to the ground) to approximately 70 degrees for maximum flexibility and comfort. The Double Chaise Loungers have two separately adjustable backs. Perfect for relaxing, snoozing, reading, or just enjoying the sun.

B. Snack Trays

The La Grange Loungers come with Slide-Out Snack Tray(s). Single Chaise Loungers have one tray on the right side (standard) but you can choose to have yours on the left side. Both Honeymoon and Double Chaise Loungers have trays on both sides.



Shown La Grange Redwood Lounger with Snack Trays.

The Slide-Out Snack Tray(s) is a wooden shelf that slides out when needed either on the right, left of both sides lounger. It's perfect for holding drinks, snacks or your favorite reading material.

C. Lounger Height

All loungers are photographed at the standard 13" height. But we can also build your lounger bed at a 15.5" or 18" height.

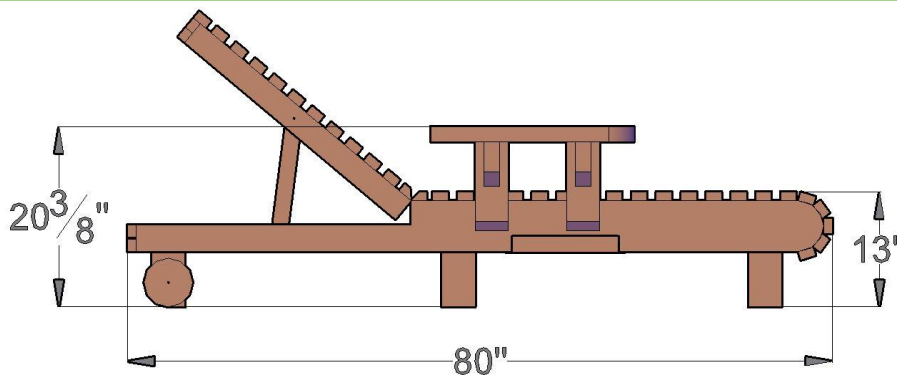

Lateral View – 13"

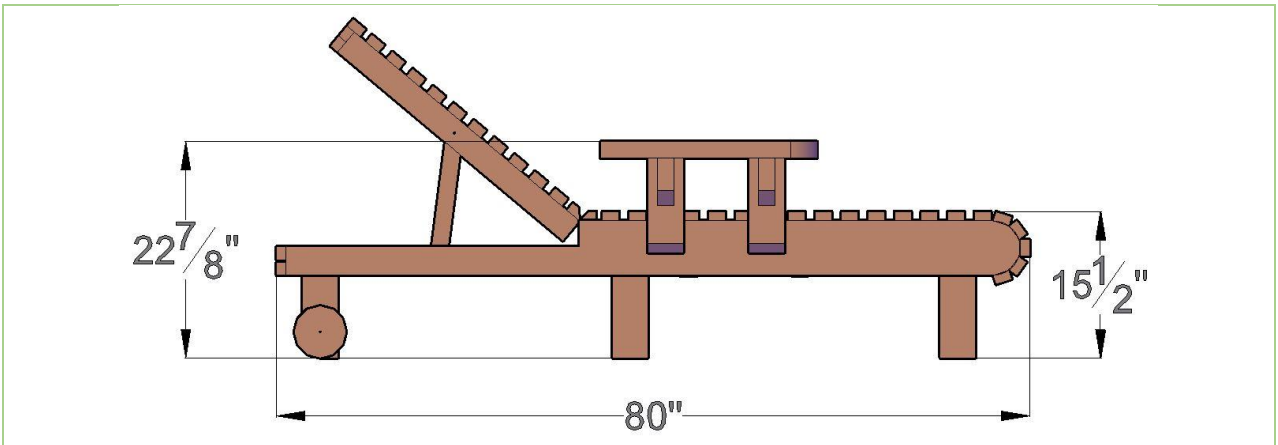

Lateral View – 15 1/2"

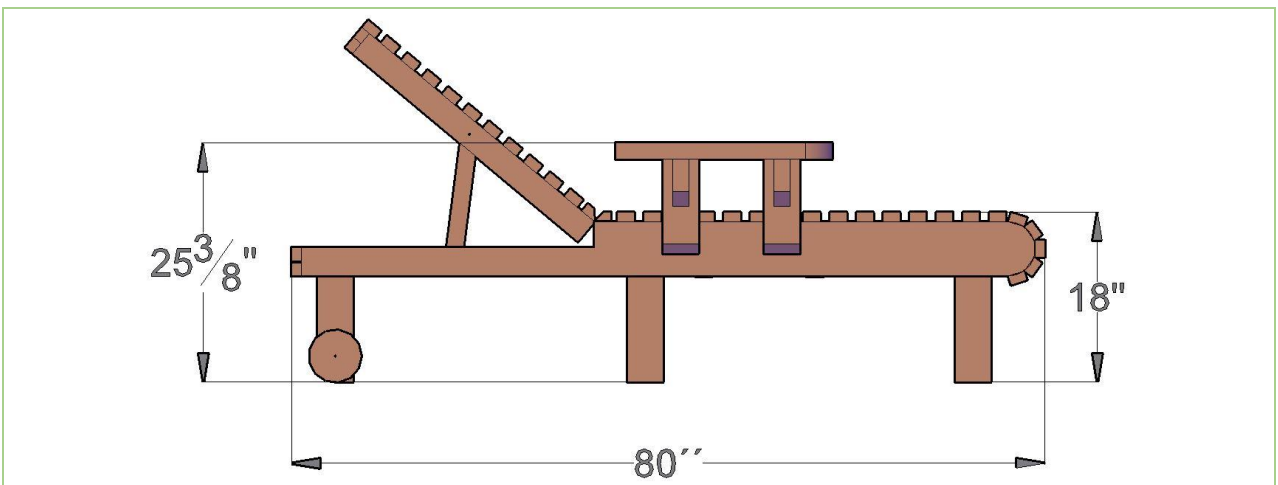

Lateral View – 18"

D. Lounger Wheels

You can order your chaise loungers with or without wheels (no extra cost).



E. Custom Cushions Sections



5 Section (Standard) Most Popular

The five section cushion (two panels for the backrests and three for the beds that folds up accordion style our most compact design.



3 Section

The three section cushion is made with 3 separate panels to make folding easier.



2 Section

With just one seam separating the backrest from the bed (2-section design) see first photo above (not recommended for the Penny Loungers).

F. Custom Cushions

If you'd like a cushion for your chairs, please indicate this in the Advanced Options section. Standard cushions come in forest green however you also have the option to visit [Trivantage](#) to choose from the hundreds of outdoor fabrics they have for your cushion.



If you want a cushion in a color other than forest green, just select Custom color cushion and note the name and number you'd like in the comments box (visit [Trivantage](#) to choose from the hundreds of outdoor fabrics they have for your cushion). Most upholstery fabrics are under \$30/yard and are included in the cushion price. If you prefer a premium fabric over \$30/yard, the cost over \$30/yard will be manually added to your order total after checkout and you will be notified of any additional charge.

It's machine washable. Each cushion has a zipper so you can remove the foam and wash the fabric easily.

Single sized loungers use 3 yards of fabric, the Honeymooner uses 4, and the Double uses 5. Lounger cushions are box construction with the fabric cut flush to the edge creating a line along the borders (no welt). The bottom side is made with a thick rubbery fabric to help keep the cushion from sliding. All lounge cushions come with straps to tie the cushion to the lounge. Your cushion can be made in three ways (same price):

- With just one seam separating the backrest from the bed (2-section design) see first product photo above (not recommended for the curvaceous Penny Loungers).
- Or for space saving, a second seam is added to the bed so the cushion folds compactly in 3 sections (recommended design for most of our Loungers).
- Or, the most compact design is made with five sections (two for the backrests and three for the beds that folds up accordion style) see other photos above.

Each lounge cushion has a 2" thick "pillow" cushion at the top of the backrest(s). The pillow cushion can be flipped back when you don't want to use it. The double lounge cushions all have independent separate backrest cushions to allow for independent backrest positions.

G. Finish Options

All our furniture ships finely sanded to 220 grit for a smooth to the touch finish.

The most popular finish is our Transparent Premium Sealant. This sealant leaves your furniture looking natural and helps keep the beautiful wood surface colors from fading for several years. We use Sikkens brand finishes because they are the best finishes on the market. For more information about our finishes and how to keep your furniture looking great year after year, please go to: [Care & Finish](#).

Unfinished (fine sanding only):





If you are applying your own stain or want the surface color to fade to a "weathered look" in a few months. We do not recommend you leave your furniture unfinished outdoors for any extended period regardless of wood quality. Outdoor weather changes constantly and it is best to at least seal the wood to protect it from consistently absorbing and losing moisture.

Transparent Premium Sealant - Recommended for Outdoors:

Below are the 5 grades of wood we offer with the Transparent Premium Sealant applied. The color tones shown are close representations of the color your furniture will look like. There is no extra charge for the Transparent Premium Sealant:

				
Douglas Fir (10 yr. Warranty)	Mosaic Eco-Wood (10 yr. Warranty)	Redwood (15 yr. Warranty)	Mature Redwood (20 yr. Warranty)	Old Growth Redwood (30 yr. Warranty)

We also offer the Transparent Premium Sealant with the following stains. There is a small charge for adding these stains because it increases the total amount of coats to 4 with the sealant as the final coats:

				
Transparent	Cherry Stain	Coffee Stain	Black Premium Stain	White Wash



Here is how the Coffee Stain looks like on Redwood



Here is how the Cherry Stain looks like on Redwood



Here is how the Black Premium Stain looks like on Redwood



Here is how the White Wash looks like on Redwood

Tiger Stripe Effect

Douglas-Fir when stained dark creates a "tiger stripe" effect as shown in this photo. It is beautiful and most customers love it. If you are looking for a dark consistent stain and do not want to see a "tiger stripe effect", please go with any of the Redwood grades for a more consistent stain finish.



Primers

- **Off-White Oil-Based Primer:** If you are painting a light color. We apply two coats so that it is ready for one final coat.
- **Gray Oil-Based Primer:** If you are painting a darker color. We apply two coats so that it is ready for the final coat.

III. ASSEMBLY & CARE

Assembly Instructions for: [Single and Honeymoon La Grange Chaise Loungers](#)

Assembly Instructions for: [Double La Grange Chaise Loungers](#)

All You Need is a Few Tools and a Friend.

Assembly is best done by two people and usually takes about half a day to a day, depending on size. Pergolas need a ratchet wrench, a hammer and a ladder to put them together. In some cases, you might need a drill to attach the posts into concrete. As with all our products, we preassemble pergolas in our shop to ensure everything fits together. All hardware is included and all parts are clearly labeled before it is shipped. We also include detailed step-by-step instructions.

Take a look at our assembly instructions below for specific details. If you plan to pour concrete to hold the posts, the project will require an additional half day prior to assembly. Please do the concrete pour a few days prior to assembly to allow the concrete to cure.

Installation Help.

Special talent is not required to re-assemble our pergolas. But, if you would like help, [just let us know](#). We have our own team for installations in California, Nevada and Southern Arizona and a network of local contractors we recommend for farther afield.

Care: Your Forever Redwood Furniture will last for decades in year-round weather without maintenance.

Depending on the wood grade you choose, even with harsh year-round outdoor conditions, you can expect your furniture to last from ten to forty years without maintenance of any kind.

Being outside year-round is rough on any woods finish. The surface absorbs UV rays, pollution, constant variations in moisture and temperature and it also oxidizes. This is why most wood just doesn't hold up and the surface color slowly changes towards a silver patina over the years. But, with Forever Redwood, you don't have to worry. The silver patina is surface deep only (less than 1/64") and is not indicative of decay. Your set will last decades and is not compromised in any way by the surface color change. For example, we keep our display items as is without refinishing to show off this natural aging (we like the patina!).

Although Forever Redwood is maintenance-free, we recommended you take a few minutes as needed to clean by either hosing down and/or brushing/dusting away accumulated debris (no soap or chemicals needed). If you'd like to keep your set looking its best for decades, please go to: [Care and Finish](#).

IV. MATERIALS

The secret to outdoor longevity begins and ends with the wood. We use generous amounts of the most decay resistant wood available. We encourage our customers to compare photos of our items side by side with any competing product. Thickness counts. Furniture that is thin and light simply won't last in the year round weather.

To keep your furniture beautiful, we use only stainless steel hardware and the highest quality stains and sealants. We use only the Sickens brand of sealants.

Our primary customer has always been the homeowner that appreciates spending a bit more for quality that will last decades.

Our products are installed with organizations that appreciate longevity like the U.S. Forest Service, U.S. military installations, State and City parks, golf clubs and hotels.

We are favored by many landscape architects and contractors because they can count on exceptional quality and quick personal service to complete projects.

We build each item by hand. This insures your set is finely finished and carefully inspected. Old-fashioned hand building also allows us to adjust the size or design of any item to fit your needs.

Because we are a forestry company, we can offer 5 exceptional wood grades to choose from our carefully managed forests with warranties of up to 30 years against decay in any weather. [Click for more about our 5 wood grades.](#)

V. WARRANTY

Wood decay is warranted up to 30 years depending on the wood grade. No other outdoor furniture manufacturer has warranties like this. The key is the excellent quality of our wood and the extra-thick timber designs of all our pieces.

Wood Grades and Decay Warranty:

- Douglas-fir: 10 years
- Mosaic Eco-Wood: 10 years
- Redwood: 15 years
- Mature Redwood: 20 years
- Old-Growth Redwood: 30 years

Forever Redwood stands behind its products. We are committed to quickly resolving any issues that might occur. For more information please see our [Warranty](#) page.

VI. SHIPPING

We offer 4 Shipping Options in the U.S.:

- Rush Shipping (ships in 3 weeks).
- Priority Shipping (ships in 6 weeks).
- Standard Shipping (ships in 10 weeks).
- Free Shipping in the Continental U.S. (ships in 14 weeks).

Notes for Orders requiring drawings or approvals:

All Shade Structure orders (Pergolas, Pavilions, Gazebos and Arbors) require drawings to make sure all details are agreed upon prior to building and to give our customers the ability to customize their structures to meet their needs. We also sometimes make custom changes to Swings, Planters, Benches, Tables and other standard production items per customer requests. If your order has a custom detail or is a shade structure, you will receive your first drawings via email within 5 business days of receiving your completed order with a deposit.

We will go back and forth with you as needed to fine tune the design to your liking prior to building it. Once you sign off on your drawings, your timeline for shipping will begin. Please keep this in mind. If you need a Rush Order and also drawings, it is best you call in your order so that we can organize ourselves to both complete your drawings on an expedited basis and meet your shipping deadline.

Yes, you can have free shipping plus save 3% off your order! We carefully hand build each Forever Redwood item. When you choose a longer ship out date, you give us more time to build. This lowers our cost and we pass the savings to you. If you choose the Wait & Save Shipping option and prefer we ship out on a specific date (up to 6 months in advance), just enter the date in the Comment Box at Checkout. If no note is included, we'll ship in 3 months.

Orders ship from San Diego, CA. Add 3 to 6 business days transit time (depending on location). We ship to any country. Canada orders ship in 6 weeks. To see Canadian shipping costs, just add item to cart.

For orders outside the U.S. or Canada, just enter your country in the shipping information section at checkout or in the shopping cart to see your freight cost. We ship outside the U.S. or Canada in 6 weeks. For all international shipments, the shipping companies handle any customs paperwork and then contact you to arrange delivery.

Assembly Service Available Nationwide: All orders over \$3,000. in size can choose to have Forever Redwood assemble for you. Just choose White Glove Service in the Shopping Cart or at Checkout. For more information on White Glove, please go to: [WHITE GLOVE](#).



If your artistically inclined, the crating makes a great canvas to:
Lion of the Tribe of Juda by Patricia Vallejo



Some of the ugly guys from our install crew that will scare your children when they come install your order!