



# FOREVER I REDWOOD

*From the Forest, For the Forest since 1995*

---

866.332.2403 (TOLL FREE); 7am – 7pm Pacific Time, Monday-Saturday

## THE SUN PERGOLA

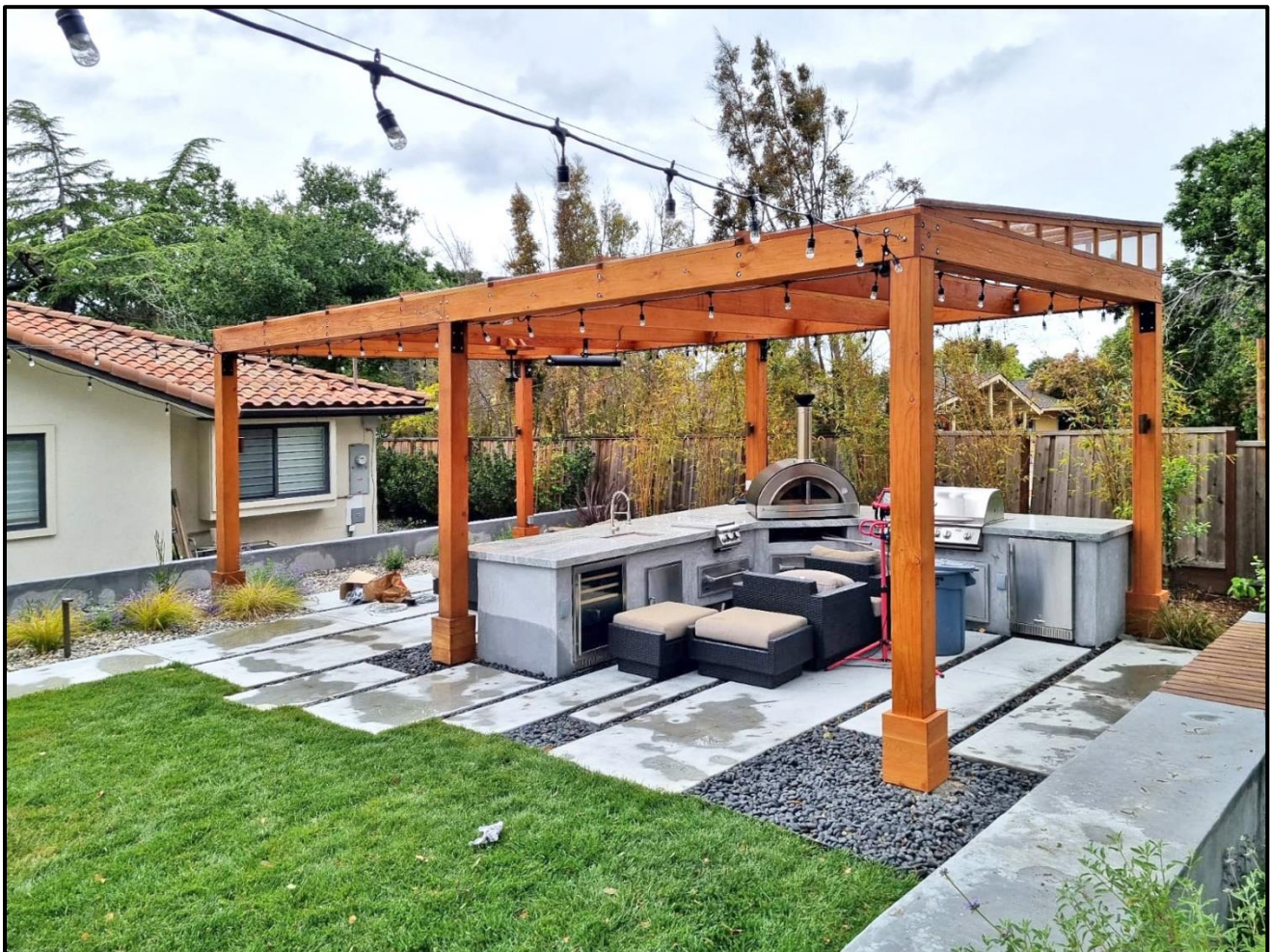

# CONTENT

I. DESCRIPTION .....	2
II. SPECIFICATIONS .....	3
A. Dimensions & Drawings (Provided prior to construction) .....	3
B. Privacy Panels Styles.....	6
1. You can add Lattice Privacy Panels to your Pergola or Pavilion: .....	6
2. You can add Shutter Panels to your Pergola or Pavilion:.....	8
3. You can add Louvered Panels for you Pergola or Pavilion:.....	8
C. Pergola Height (Post size) .....	9
D. Electrical Wiring Trim Kit .....	9
E. Pergola Post Anchoring.....	10
1. Option 1: Standard Anchor Kit.....	10
2. Option 2: High-Wind Anchor Kit.....	13
F. Post Decorative Trim.....	15
G. Accessory Bases & Shelving.....	16
H. Curtain Rods.....	17
I. Privacy Panels Quantity .....	18
1. Lattice Privacy Panels.....	19
2. Shutter Privacy Panels .....	20
3. Louver Privacy Panels .....	20
J. Finish Options .....	21
III. ASSEMBLY & CARE.....	25
IV. MATERIALS .....	26
V. WARRANTY .....	26
VI. SHIPPING.....	27

## I. DESCRIPTION

The Forever Redwood Retractable Canopy Pergola is an excellent shade solution. You can build the lovely modern pergola structure any size you need and with our partnership with Infinity Canopy's retractable shade systems you can adjust the amount of shade you need in seconds.

- **We are a turnkey one stop shop:** We will design and size your pergola with you, build, deliver and install anywhere in the Continental U.S. If you are a Do It Yourselfer, you can put up most kits in one day since they ship pre-marked and finished in pieces that have been assembled in the shop beforehand.
- The Retractable Canopy Pergola is a thick timber design hybrid that combines the retractable shade canopies made by Infinity Canopy ([www.infinitycanopy.com](http://www.infinitycanopy.com)). We do not provide the canopy directly, but instead, send your approved final design to Infinity Canopy so they can custom size your shade solution and add the options you like (fabric color, etc.).
- The key to a successful long-term pergola project begins with the wood quality, then includes sizing, orientation, design and construction details. For example, the key to maximizing shade while maintaining as open a roof line as possible is to orient the main roof timbers north and south so that the sunrays are blocked as the sun rises and sets over the main roof rafters in the morning and late afternoons.
- Each Wooden Pergola is built your way. Our dedicated staff of designers and consultants stay with your ideas until we have something you are completely in love with. Every detail can be a standard option or customized as needed. If you want to add a detail or a size you do not see, just say the word.
- We are a forestry company. We hand select the best, fattest timbers from our forestlands for your project. Everything is ridiculously over built. All real wood and steel - no plastic/vinyl/ compressed glue/plywood or flimsy hardware or nails. Nothing lasts longer than California Redwood outdoors. We have over 20 years' experience building, shipping and installing shade structures all over the country.
- **Easy Design/Sizing Support:** Your order's drawings are emailed within 5 days. The drawings are ideal so you don't have to figure it out beforehand. Usually just a couple emails with our design team is all you need until every detail is the way you want.
- **Details Matter:** All joints are notched so your [Retractable Canopy Pergola kit](#) will never sag, warp, twist, or shrink. Each timber is finely sanded to a smooth to the touch feel. We use the best sealants on the market. We really do make the best wood shade structures you can buy anywhere. Check the competition carefully. Does any other manufacturer offer up to 30-year decay warranties?
- **You Install or We Install?** Once you sign off on your drawings, your Pergola is fully erected and finely finished in the shop for easy re-assembly. All the stainless steel hardware is included. Just bolt the timbers back together. Most kits go back up in 6 to 8 hours with one helper (see Assembly & Care tab above). And, if you do not want to do the work, we can send our install team anywhere in the U.S.

- **Turnaround Time & Financing:** We can build in 2 to 3 weeks, but we recommend ordering 2 to 3 months in advance to have time to fine tune the details via the drawings. You can also take advantage of our 1/3rd deposit option on site to spread out the cash via a couple monthly payments.

To find out more about our one-of-a-kind Retractable Shade Canopy Pergola Kit, or any of our other products, give us a call today, or shoot us an email here.

Questions? - [Download](#) the eBook "Everything you Wanted to Know about Pergolas" for answers to frequently asked questions or please contact our [Pergola Advisor](#).

## II. SPECIFICATIONS

### A. Dimensions & Drawings (Provided prior to construction)

When we receive any Pergola order, we will provide you with a detailed set of drawings based on the options and sizes chosen. The drawings will clearly show all the details and dimensions from 3 different angles. They are an excellent tool for you to double check everything to be sure it is exactly as you'd like before it is built. Drawings are emailed within 5 business days and we'll revise your drawings as needed to make sure all details and sizing issues are perfected prior to beginning construction.

Below are some examples of drawings sent to prior customers:

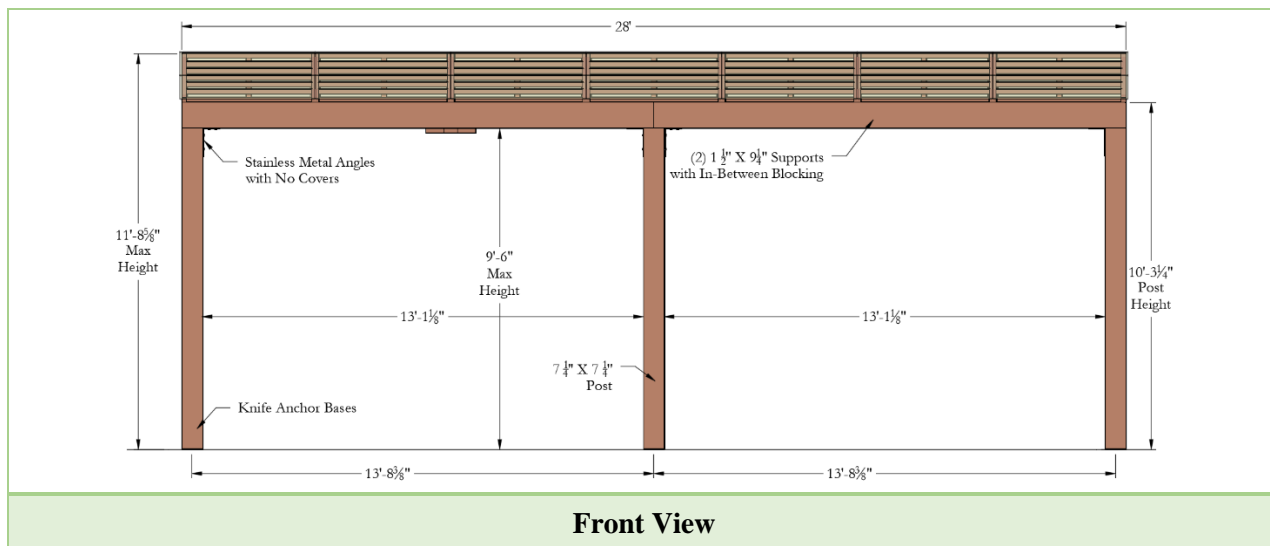

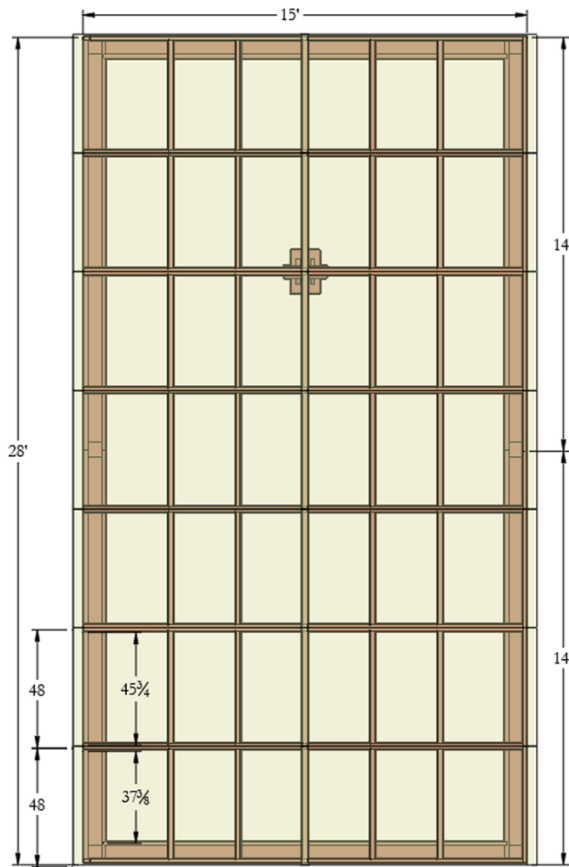

Top View

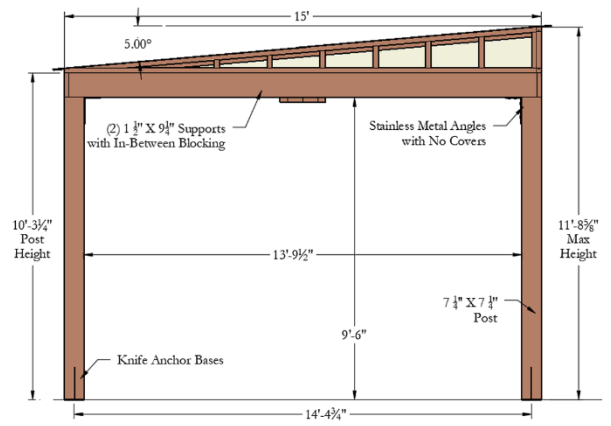

Side View



Isometric View

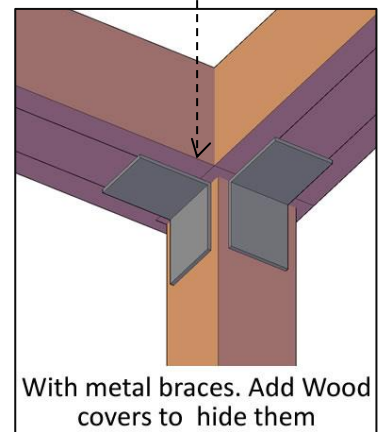
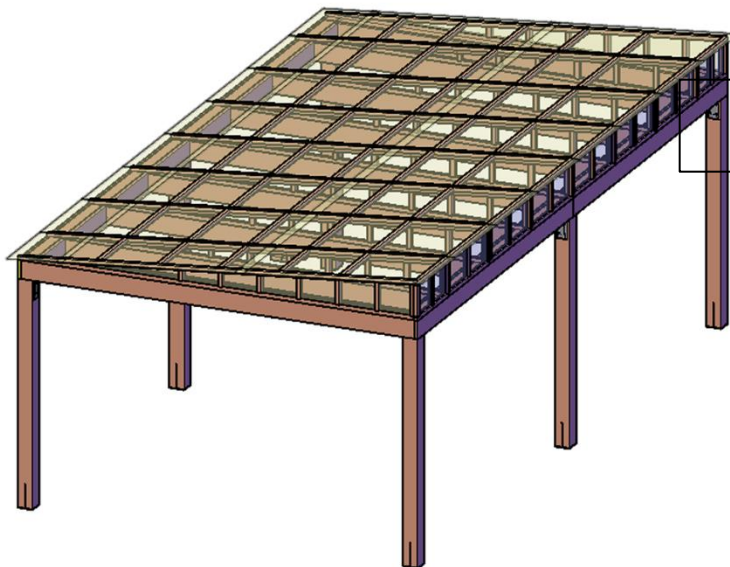

Junction Plaque Detail

Corner posts are 5 1/2" by 5 1/2" (standard sized 6x6s) and are recessed 12" in from roof dimensions (This can be adjusted to meet your needs just let us know).

Roof support timbers (lintels) and rafters are 1 7/8" x 5 3/4". If you prefer a different sizing or style write what you would like in the comments section or [contact us](#).

Posts normally ship 9' long. 9 posts make the top of the roof 9' also and give you an 8' 4" clearance ("ceiling height") under the rafters. About 90% of our pergola customers go with the default 9' post height. If you'd like your pergola taller or shorter, just select Other Height and write in what you would like in the comments section.

The maximum roof size is 20' in either direction with a 4 post structure. The maximum span (with the standard timber sizes mentioned above) is 18' 2 1/2" on center between posts. Structures over 20' in any direction are built with an additional post to support roofs between 20 and 40 feet. For example, a 30' x 20' free standing pergola has 6 posts.

Forever Redwood Pergola kits are completely assembled in the shop prior to shipping to be certain everything fits together perfectly. All timbers are notched into one another to increase structural strength and to lock all your pergolas timbers in place so they will never sag, twist or move. There are hundreds of notches in the larger pergolas. Full notching is rarely practiced because it is labor intensive, but it is one of the secrets to a long lasting beautiful pergola.

All assembly hardware is included and is stainless steel.

Pergola (Roof) Size (ft.)	Approx. Weight
10' x 10'	705 lbs.
10' x 12'	795 lbs.
10' x 14'	885 lbs.
10' x 15'	930 lbs.
10' x 16'	975 lbs.
10' x 18'	1065 lbs.
10' x 20'	1155 lbs.
12' x 12'	903 lbs.
12' x 14'	1011 lbs.
12' x 15'	1065 lbs.
12' x 16'	1119 lbs.
12' x 18'	1227 lbs.
12' x 20'	1335 lbs.

Pergola (Roof) Size (ft.)	Approx. Weight
14' x 14'	1137 lbs.
14' x 16'	1263 lbs.
14' x 18'	1389 lbs.
14' x 20'	1515 lbs.
15' x 15'	1268 lbs.
15' x 18'	1470 lbs.
15' x 20'	1605 lbs.
16' x 16'	1407 lbs.
16' x 18'	1551 lbs.
16' x 20'	1695 lbs.
18' x 18'	1713 lbs.
18' x 20'	1875 lbs.
20' x 20'	2055 lbs.

For additional long-term structural strength, we add solid timber blocking in-between the dual support timbers as shown in the drawing below. With this blocking, the dual supports are in effect converted into one solid 5 3/4-inch x 6 1/2 inch or 7 1/4-inch x 6 1/2-inch timber as shown below:

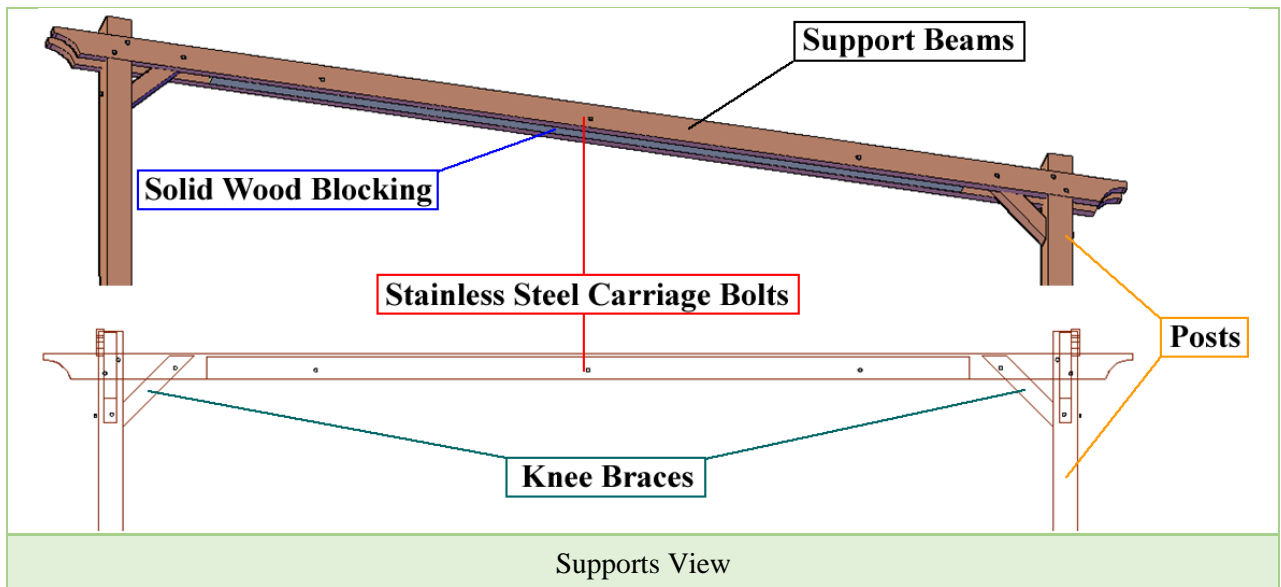

## B. Privacy Panels Styles

If you need additional shading or privacy for the sides of your Pergola or Pavilion, we have several options you can choose from. And, if you do not see an option you are interested in, let us know during the drawing process of your order and we can help design a custom privacy option of your own creation.

Some of our more popular privacy options can be applied to one side or several. They can be half walled or full wall for maximum privacy. You can add the half wall options anywhere you like: top, bottom or halfway. Yes, you are in charge of the final design details 100%:

1. You can add Lattice Privacy Panels to your Pergola or Pavilion:

The lattice is normally made with 1 3/4" W slats with 1 3/4" W openings that are diagonal. We offer you several options with the Lattice Privacy Panels:

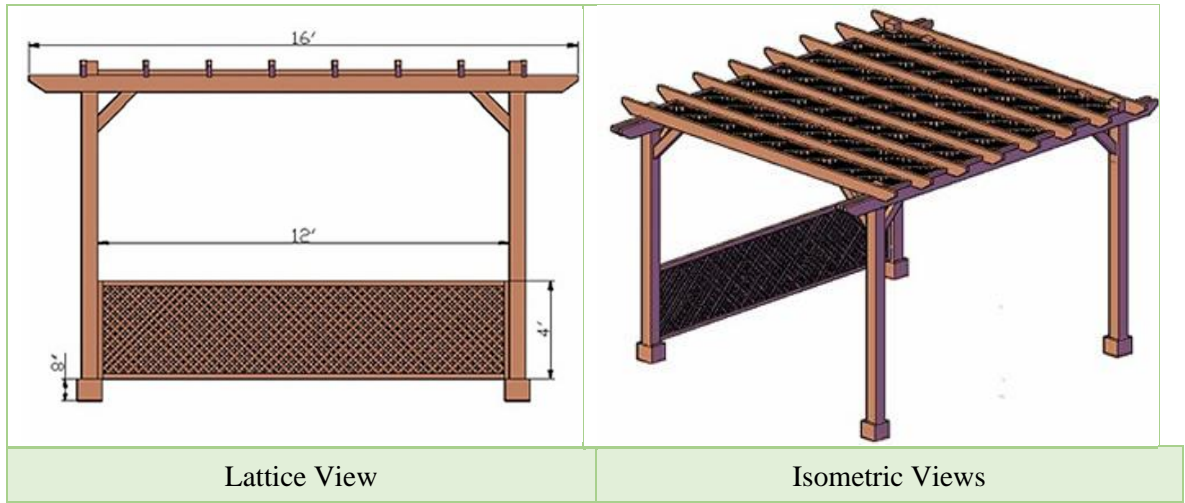

Lattice View

Isometric Views



Lattice Privacy Panels

- Lattice Privacy Panels can be up to 48" H each. If you prefer a shorter height, just let us know in the comment box at checkout. If you want to have privacy panels from the roof to the ground on one or more sides, you'll need 2 panels to cover the approximate 8' height.
- Lattice Privacy Panel(s) can be made long enough to fit between the posts of a 20' roof side (after taking into account the 1' overhang beyond the posts and the width of the posts, this leaves up to a 17' 1" distance you can cover with any of our Privacy Panel options). You have the option of adding as many panels as you like. We always prepare drawings prior to building any Pergola. So, you'll have time to review your initial selection and make any changes to be certain the Privacy Panels are located where you'd like and that they are the correct height and height off the ground, etc.
- When ordering Lattice Privacy Panels, please let us know in the Comments Box at checkout the height off the ground you'd like the bottom of your panel(s) to be we'll drill installation holes in the posts to achieve the height you specify. If no height is specified,



we'll ship your posts without holes so you can determine the best height during installation.

2. You can add Shutter Panels to your Pergola or Pavilion:

We can build your Privacy Panels as shutters. The shutters sections open in and the bottom half of the wall is usually a solid wood panels as shown. Shutters are fixed and do not open and close. Shutter panels are normally made full length from 6 inches above the ground to the height of the first timber in the roof or 8' total height. The shutter privacy option is also available in a half height panel and in a full height panel that is all shutters. If you require a different option/combo or total height, let us know.



3. You can add Louvered Panels for you Pergola or Pavilion:

We can build your privacy panels as louvers. You can have louvers installed for your Pergola for maximum flexibility in terms of light allowed in and privacy. Louver panels are made up to 8' tall and the louvers normally begin 6" off the ground. We offer the panels with louvers only or with louvers the top half and a solid wall below. You can also just order a half height louver panel (48" H) only. If you require louvers of a special size or shape, please let us know. If you would like to combine louvers and shutters or any other custom request, you can add these custom details during the drawing process of your shade structure order.

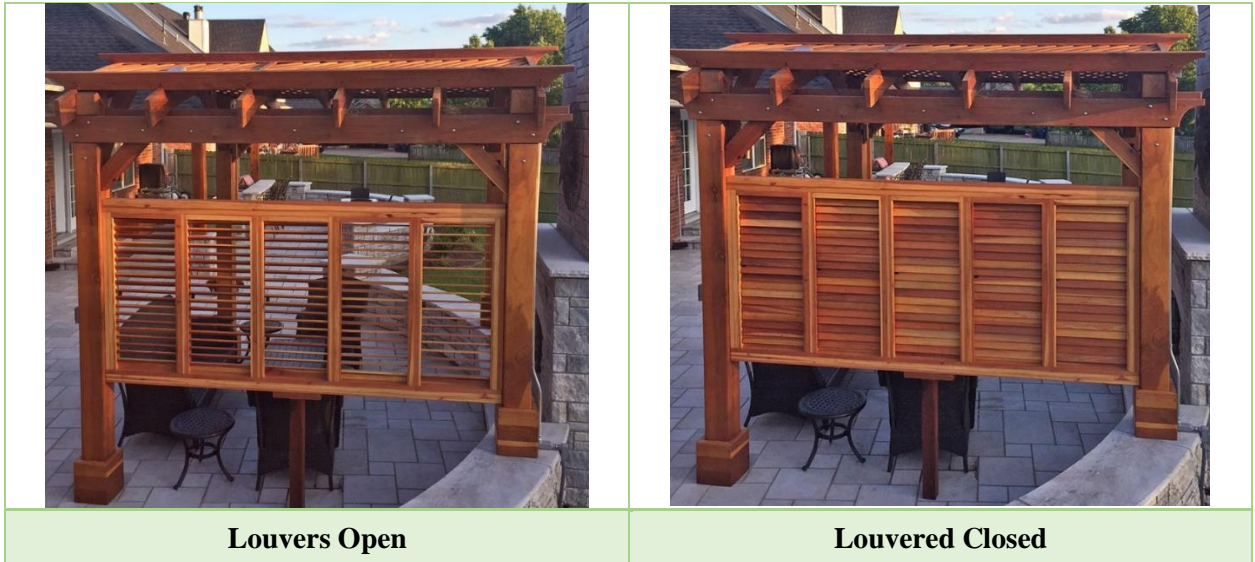

### C. Pergola Height (Post size)

The standard pergola height is usually 9ft. and 90% of our installations are this height. Attached to ground level a 9ft post will create an 8' 4" ceiling height under the rafters. We also offer post lengths of 8.5 ft., 9.5ft and 10 ft. Note for any of these your ceiling height will be 8 inches less than the post size selected.

For this size or any custom length, just note the size you want in the Comments/Special Request section. We'll contact you if it changes the pricing of your pergola.

### D. Electrical Wiring Trim Kit

If you plan to run wiring to add lights or a fan or two to your Structure, we can add a cutout to your timbers and add a trim piece that will hide the electrical wiring beneath it (see drawings). The trim is centered on the interior side of the Post and or is added to Roof Supports. It is attached with finish nails for a smooth finish.

If you only want to add it to just one or two posts, please let us know in the Comment box which posts you'd like them on. They will be included in your Structure drawings that will be emailed to you within 5 business days of receiving your product order. At that point, you can make any adjustments in case the trim was place on the wrong post or posts.

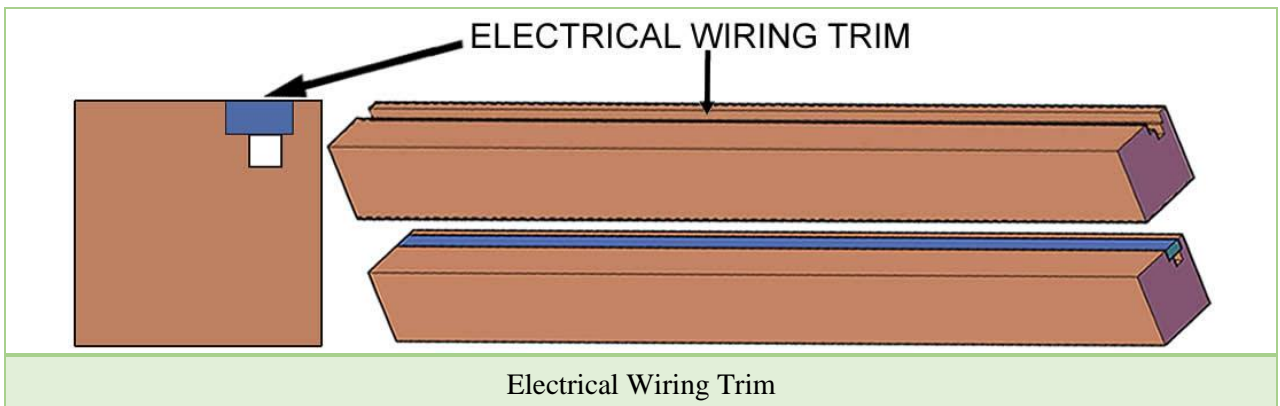
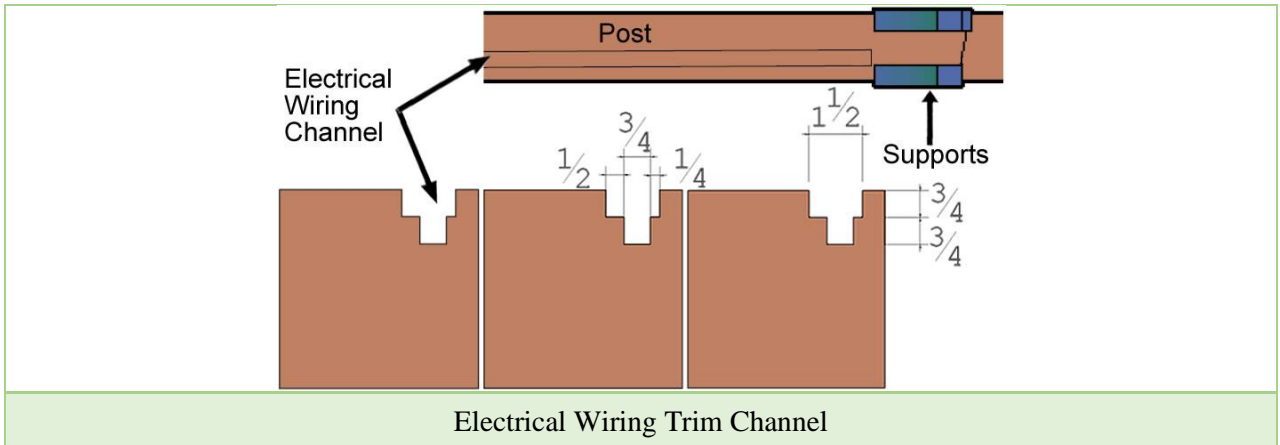

## E. Pergola Post Anchoring

*All posts should be attached to the ground. Below are the most common scenarios.*

To anchor your posts for decades to come, we recommend stainless steel anchors and bolts. Our anchor kits, whether for concrete or wood decks, come with everything you need to attach your structure securely.





### 1. Option 1: Standard Anchor Kit

The stainless steel anchors sit on the surface and attach using either 4 expansion anchor bolts (for concrete) or 4 lag bolts (if attaching to a wood deck). The posts sit in the anchor's saddle and are attached to the anchors with lag bolts provided. A wood trim box is included to hide the hardware from view (see anchor kit installation images below).

For paver, stone or flagstone patios we don't recommend attaching directly to these surfaces because you may have cracking or movement long term. Instead, we recommend installing footings (concrete foundations for the posts) to make sure you have zero issues long term.

For most applications, we recommend digging holes 30" deep (in snow areas adjust depth to go below the frost line by 6"), place cardboard Sono tubing in the hole up to ground level (see anchorage table 1 to know the diameter). Then pour concrete flush to ground level (or level with the walking surface area of your paver or flagstone patio). Allow up to 3 days for the concrete to cure before attaching metal anchors at the top of the concrete pour (see below). You can use fast drying concrete if you don't want to wait.

If you do not want the posts to wick up moisture, pour the concrete half an inch above ground level. The trim boxes will still drop to the floor and hide this detail.

				
<p><b>STEP 1:</b> Place the anchor where it will be installed; mark the ground as shown.</p>	<p><b>STEP 2:</b> Drill for holes as shown 1/2" wide hole 4" deep and hit down the anchor bolts (1/2" x 4") with a hammer. Then take off the nut before you place the metal anchor (<b>note: for wood deck use lag bolt</b>).</p>	<p><b>STEP 3:</b> Place and attach metal anchor to concrete with anchor bolt (1/2" x 4") and place the post.</p>	<p><b>STEP 4:</b> Attach post to metal anchors with lag bolts (5/16" x 3").</p>	<p><b>STEP 5:</b> Place the wood boots over the anchors, fixed it with the screws.</p>

The photos above show the 5 simple steps to follow once your surface below the Structure is in place. Choose the anchor kit for the appropriate surface:

- **Stone, Brick or Concrete - Anchor Bolts** (1/2") for attaching to stone, brick, or concrete.
- **Wood (e.g., Wood Deck) - Lag Bolts** (3/8") for attaching to a wood deck.

Read more about anchoring your Structure in our [FAQ, including the best grade of wood to choose for your climate.](#)

**More technical details:**

**Ideally Confirm your Structure Drawings prior to laying foundations** – especially for paver or flagstone patios.

By confirming your Structure drawings first you may realize that you overlooked something or you may want to make a change that will affect the length or width. For example, for a standard 10' x 12' Arched Pergola Kit, the posts are recessed back 12 inches from the edge of the roof. This places your posts at 8' x 10' to the outside 4 corners of the posts and at 7' 6 1/2" x 9' 6 1/2" on center. If you are certain this is what you want, you can do the footings before ordering your Structure and before you receive your drawings for your order (all Structure orders receive drawings within 5 business days for your review to give you the time and tool to make adjustments before building). Often, when customers see their drawings, they decide to change some detail like adding more space between the posts or going taller.

If you are in the process of laying a foundation for a Structure that will require footings (recommended for flagstone or paver patios), it is best to have the design finalized so that you or your contractor can place the footings in the exact location. Once footings are installed you will not be able to move the post positions causing yourself an unnecessary headache.

**Paver or Flagstone Patio Installation details** - If you are placing your Structure on a paver patio, pour the concrete to be level with the finished pavers. This way, after adding the trim, the bottom of the trim will rest atop the pavers seamlessly. Since the paver patio is usually a few inches above grade, you may have to pour a bit higher than on undeveloped ground to get the post height to line up exactly with the paver height. The design engineer that will be assigned to your project will detail the footings work needed as part of your design work. Below is a typical set up:

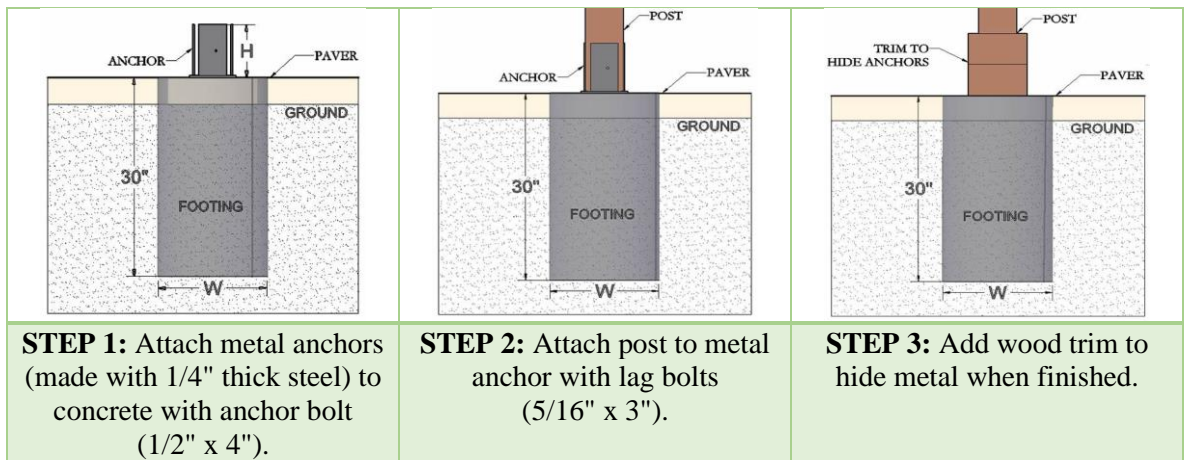

POST	ANCHOR BASES	FOOTING		
Sizes	Base Steel Gauge	H	W	Deep
3-3/4" x 3-3/4"	1/8"	6"	14"	30"

5-1/2" x 5-1/2"	1/8"	8"	16"	30"
7-1/4" x 7-1/4"	1/8"	8"	18"	30"
9-1/4" x 9-1/4"	1/8"	10"	20"	30"
11-1/4" x 11-1/4"	1/8"	10"	24"	30"

If you decide to order the Anchoring Kit you'll have all the hardware you need and will not need anything from the hardware store if you are attaching to an existing deck. If building on undeveloped ground, just add the concrete and a bit of rebar as described above. Choose the anchor kit for the appropriate surface either wood decking or stone, brick or concrete surfaces.

## 2. Option 2: High-Wind Anchor Kit



Gale Wind Anchor Kit

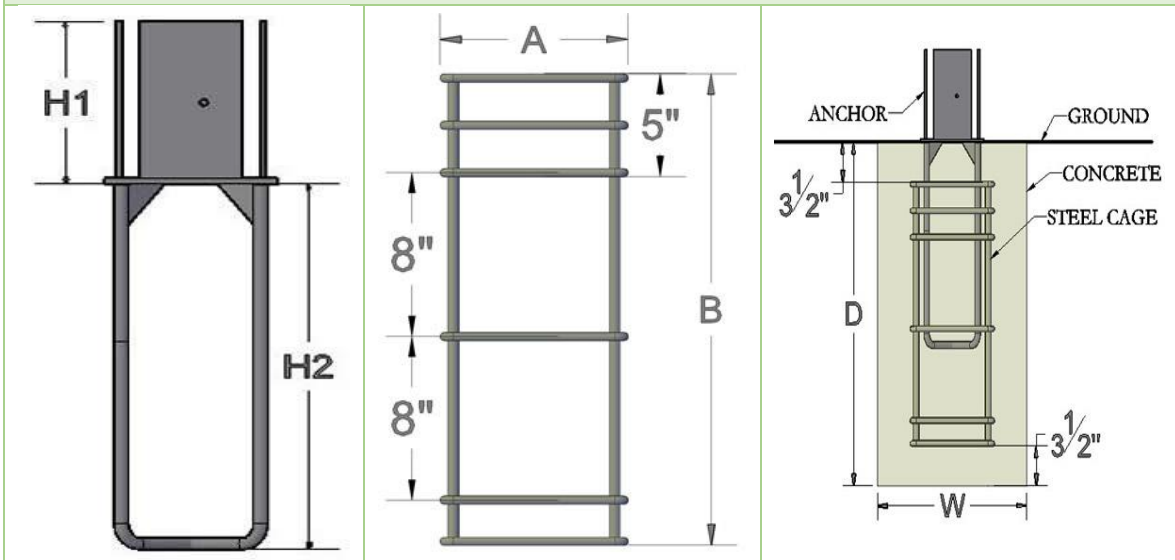

Gale Wind Anchor Kit

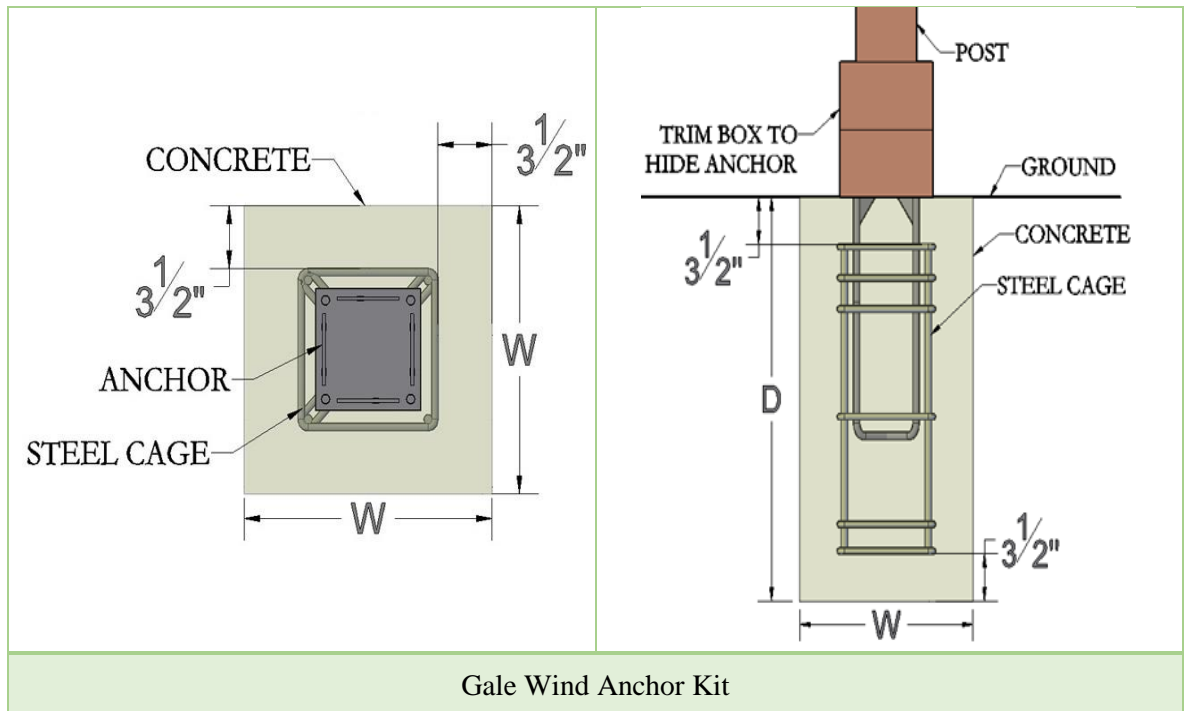

Gale Wind Anchor Kit

POSTS Sizes	ANCHOR BASES			STEEL CAGE			FOOTING	
	PTR Gauge	Anchor Steel Base (PTR)	Steel Base Diameter	H	A	B	W	D
3-3/4" x 3-3/4"	1/8"	6"	3/8"	12"	7"	23"	14"	30"
5-1/2" x 5-1/2"	1/8"	8"	3/8"	18"	9"	29"	16"	36"
7-1/4" x 7-1/4"	1/8"	8"	3/8"	18"	11"	29"	18"	36"
9-1/4" x 9-1/4"	1/8"	10"	1/2"	20"	13"	35"	20"	42"
11-1/4" x 11-1/4"	1/8"	10"	1/2"	24"	17"	35"	24"	42"

**Note:** At least 3-1/2" clearance between edge of footing and anchor is recommended.

The High Wind anchor is rated to withstand winds of up to 150 mph. They are made from 100% Stainless steel. See chart above for typical recommended footing depth, but the final footing design will be part of your final approved working drawings that you will receive as part of the ordering process. They are normally installed at a 30 to 42 inch with a significant portion of the anchor in concrete underground as shown in the drawings above. For best results, we recommend doing the concrete work at least 3 days ahead of the Structure install so the concrete will cure prior to attaching the Structure to it. You then place the wood posts in the cradle and bolt the wood to the anchor. We supply wood trim pieces to hide the hardware so the bottom of the posts look like they have a wooden boot around them when installation is complete.

**Note:** If your Structure is placed in a snow area, the concrete must be 6 inches below the frost line.

## F. Post Decorative Trim



Standard

Vertical

Horizontal



## G. Accessory Bases & Shelving

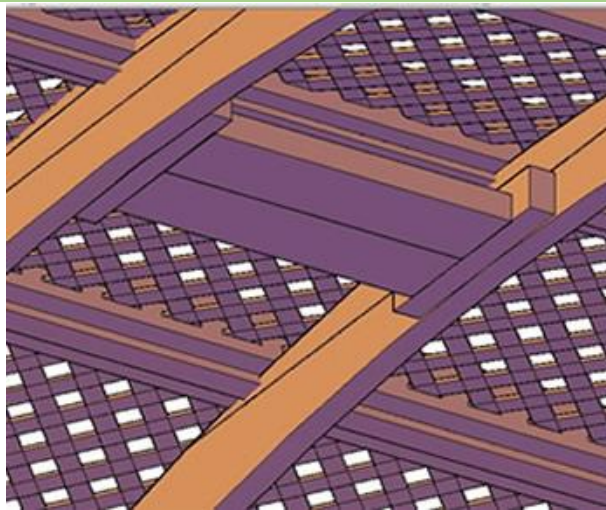

Ceiling Fan Base Drawing



Ceiling Fan Base



Roof Fan



Pavilion with 2 Ceiling Fan Base

Attach the Ceiling Fan base between the rafters with 4 bolts (two per side). The paddle fan is usually placed in the center of the Pergola's ceiling, but of course, you can place it almost anywhere you have sufficient head space.

Many customers have told us that by far the best manufacturer is a company out of Kentucky called the **Big Ass Fan** Company. Funny name, great fans. They move a lot of air, are quiet and are probably the best in the business.

## H. Curtain Rods

We can add our oversized Curtain Rods with strong steel hangars. The hardware to attach your curtain rods is included. The rods are made 2 3/4" in diameter so they can take plenty of abuse over the years.



Curtain Rods



Curtain Rods with Metal Hardware

## I. Privacy Panels Quantity

You can choose from 1 to 5 panels depending on the size of your Pavilion.

Each individual privacy panel can be either up to 48" tall or full length depending on the selection you make from the drop down menu.

The privacy panels bolt to the sides of the posts and span the entire length between posts regardless of the size of your structure. Order the amount of panels you need to bolt between posts.

If you choose a structure that exceeds 20' on any side, you will need a total of 3 posts for that side and 2 privacy panels for that side.

For sizes between 8ft to 20ft Support Length, you can choose up to 3 of privacy panels options to install between posts.

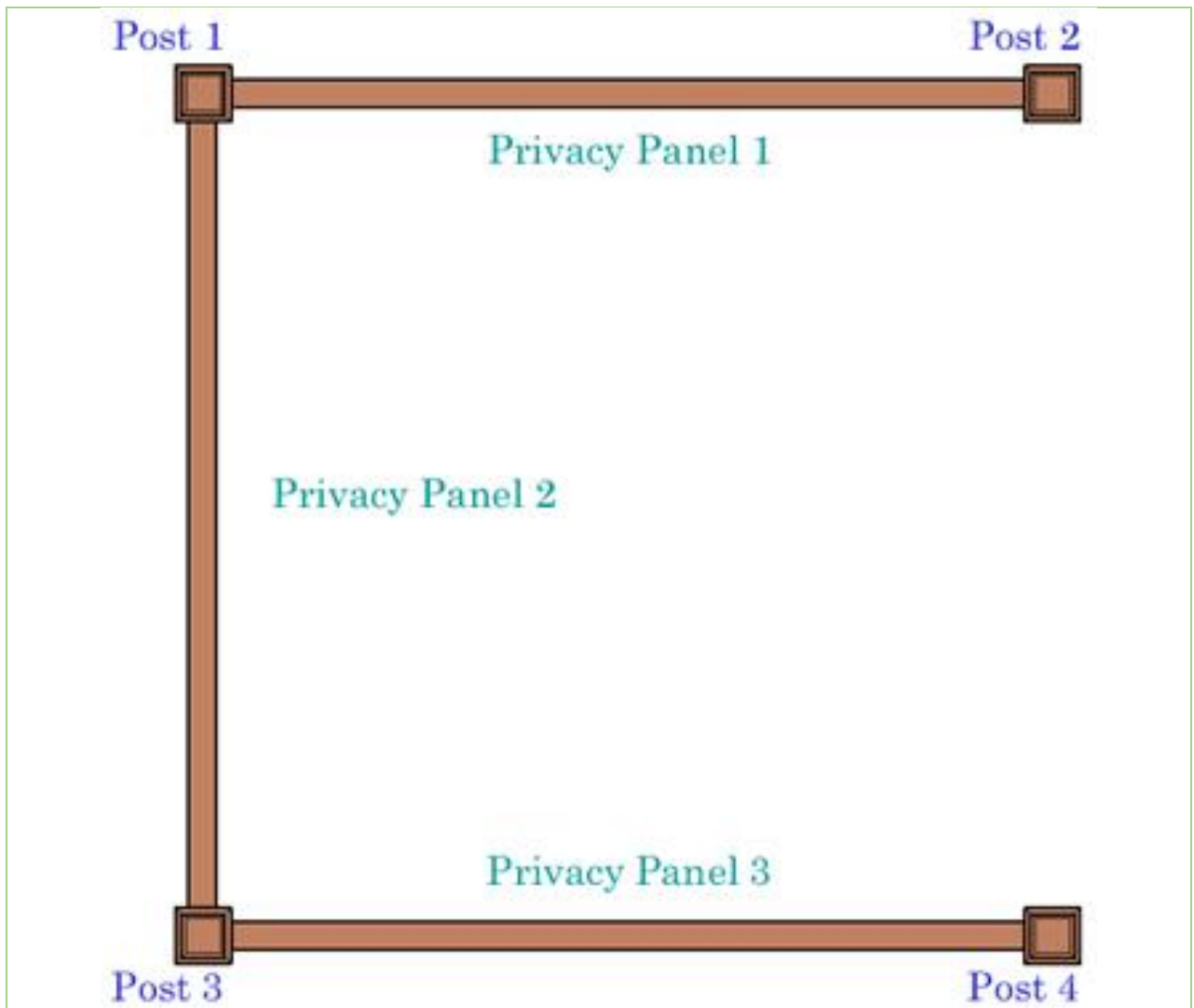

Top View of a Structure with 4 Posts and 3 Privacy Panels.

For sizes between 20ft to 40ft Support Length you can choose up to 5 of privacy panels options to install between posts.

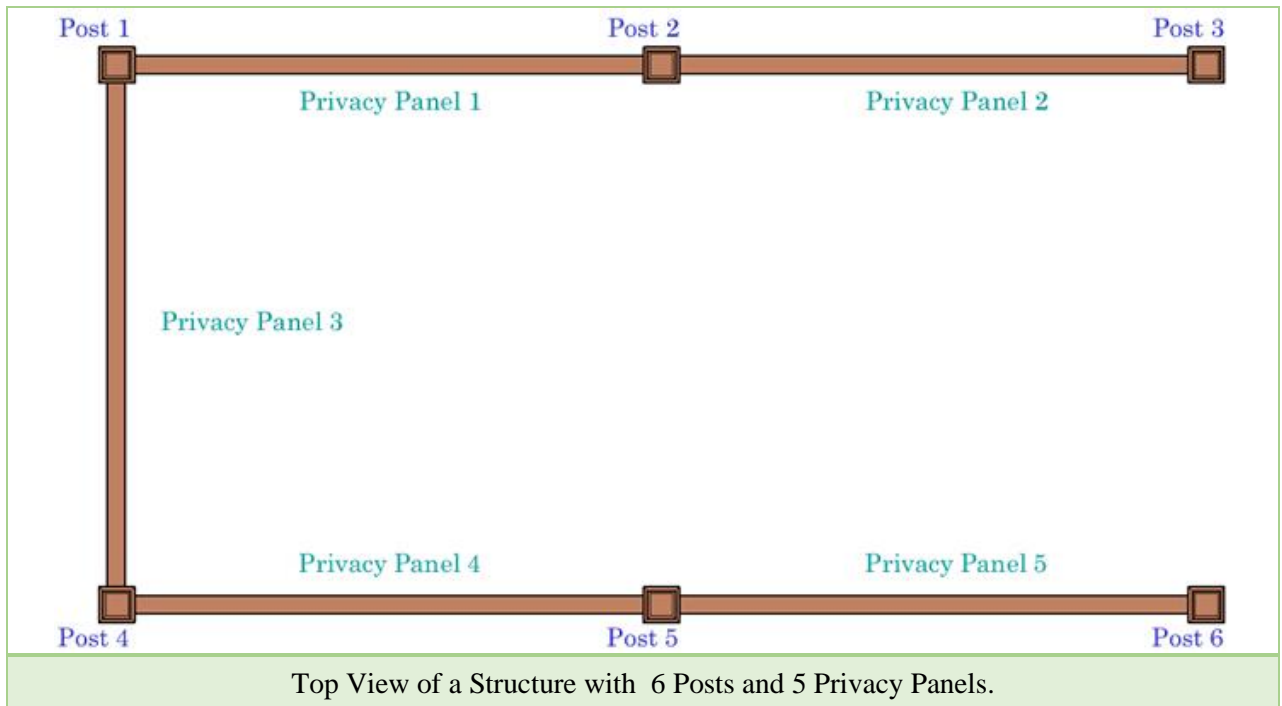

You can configure it how you wish or you need. Keep in mind we will prepare detailed drawings of your order and you will have ample time to fine tune all details including the privacy panel placement and sizing.

### 1. Lattice Privacy Panels

If you want a Lattice Privacy Panels for your structure, you can choose between one of 2 options below.

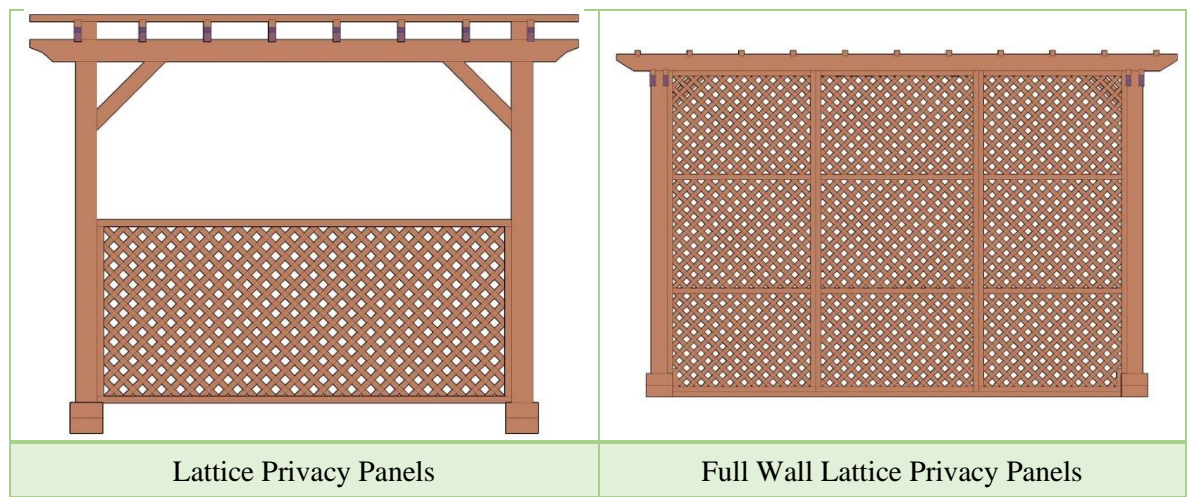

## 2. Shutter Privacy Panels

If you want a Shutter Privacy Panels for your structure, you can choice between 3 options, 2 of them can be reviewed with the drawings below.

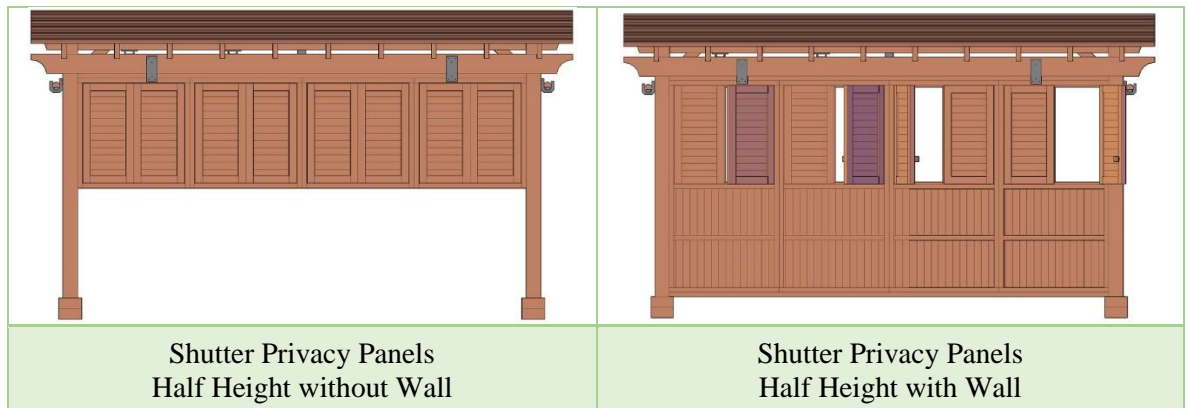

## 3. Louver Privacy Panels

If you want a Louver Privacy Panels for your structure, you can choose between one of 3 options below.

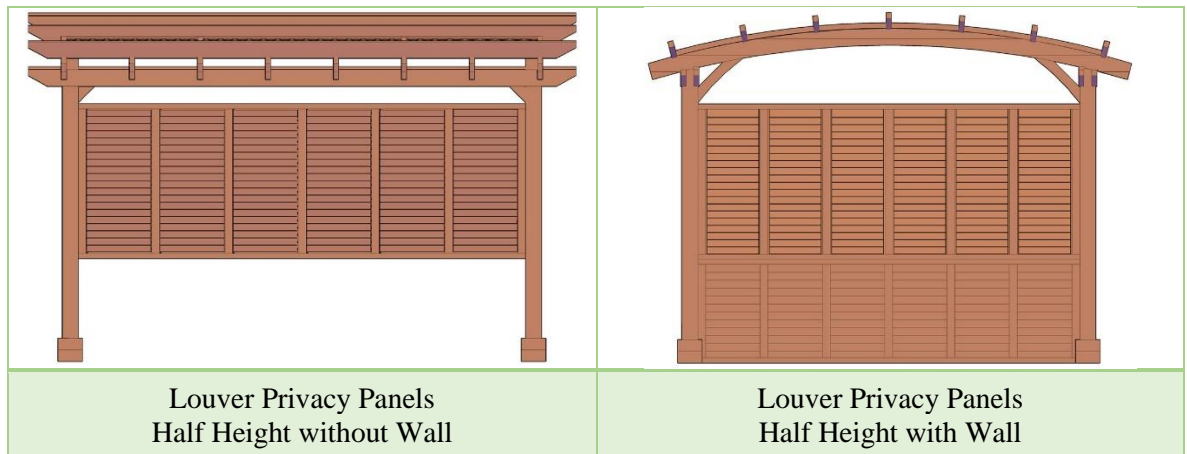

## J. Finish Options

All our furniture ships finely sanded to 220 grit for a smooth to the touch finish.

The most popular finish is our Transparent Premium Sealant. This sealant leaves your furniture looking natural and helps keep the beautiful wood surface colors from fading for several years. We use Sikkens brand finishes because they are the best finishes on the market. For more information about our finishes and how to keep your furniture looking great year after year, please go to: [Care & Finish](#).

### Unfinished (fine sanding only):

If you are applying your own stain or want the surface color to fade to a "weathered look" in a few months. We do not recommend you leave your furniture unfinished outdoors for any extended period regardless of wood quality. Outdoor weather changes constantly and it is best to at least seal the wood to protect it from consistently absorbing and losing moisture.

### Transparent Premium Sealant - Recommended for Outdoors:

Below are the 5 grades of wood we offer with the Transparent Premium Sealant applied. The color tones shown are close representations of the color your furniture will look like. There is no extra charge for the Transparent Premium Sealant:

				
Douglas Fir (10 yr. Warranty)	Mosaic Eco-Wood (10 yr. Warranty)	Redwood (15 yr. Warranty)	Mature Redwood (20 yr. Warranty)	Old Growth Redwood (30 yr. Warranty)

We also offer the Transparent Premium Sealant with the following stains. There is a small charge for adding these stains because it increases the total amount of coats to 4 with the sealant as the final coats:



Here is how the Coffee Stain looks like on Redwood



Here is how the Cherry Stain looks like on Redwood

### Tiger Stripe Effect

Douglas-Fir when stained dark creates a "tiger stripe" effect as shown in this photo. It is beautiful and most customers love it. If you are looking for a dark consistent stain and do not want to see a "tiger stripe effect", please go with any of the Redwood grades for a more consistent stain finish.



## Primers

- **Off-White Oil-Based Primer:** If you are painting a light color. We apply two coats so that it is ready for one final coat.
- **Gray Oil-Based Primer:** If you are painting a darker color. We apply two coats so that it is ready for the final coat.

## Custom Paints

Custom Paint Finish (go to [BenjaminMoore.com](http://BenjaminMoore.com)):

Have Forever Redwood paint your order any color you like. We prefer to use Benjamin Moore paints because they make excellent quality products and offer a huge selection of paints and colors to choose from.





*Modern Louvered Pergola – Black Stain*



*Benjamin Moore: Black Stain, 2131-10*

First select the type of paint you want: [Benjaminmoore.com](http://Benjaminmoore.com)

Then click the colors tab and choose from the almost endless amount of colors offered.

Just select the Custom Paint finish option and in the Comment box enter the type of paint and the name and number of the color you would like. We will confirm your custom paint request within 24 hours of receiving your order and we will order the paint for you and apply per the specified directions. You only need to let us know the type of paint and the color name and number and we will do the rest.

### III. ASSEMBLY & CARE

Assembly Instructions for: [Retractable Canopy Pergola](#).

Assembly Instructions for: [How to Anchor Your Pergola](#).

#### **All You Need is a Few Tools and a Friend.**

Assembly is best done by two people and usually takes about half a day to a day, depending on size. Pergolas need a ratchet wrench, a hammer and a ladder to put them together. In some cases, you might need a drill to attach the posts into concrete. As with all our products, we preassemble pergolas in our shop to ensure everything fits together. All hardware is included and all parts are clearly labeled before it is shipped. We also include detailed step-by-step instructions.

Take a look at our assembly instructions below for specific details. If you plan to pour concrete to hold the posts, the project will require an additional half day prior to assembly. Please do the concrete pour a few days prior to assembly to allow the concrete to cure.

#### **Installation Help.**

Special talent is not required to re-assemble our pergolas. But, if you would like help, [just let us know](#). We have our own team for installations in California, Nevada and Southern Arizona and a network of local contractors we recommend for farther afield.

**Care:** Your Forever Redwood Furniture will last for decades in year-round weather without maintenance.

Depending on the wood grade you choose, even with harsh year-round outdoor conditions, you can expect your furniture to last from ten to forty years without maintenance of any kind.

Being outside year-round is rough on any woods finish. The surface absorbs UV rays, pollution, constant variations in moisture and temperature and it also oxidizes. This is why most wood just doesn't hold up and the surface color slowly changes towards a silver patina over the years. But, with Forever Redwood, you don't have to worry. The silver patina is surface deep only (less than 1/64") and is not indicative of decay. Your set will last decades and is not compromised in any way by the surface color change. For example, we keep our display items as is without refinishing to show off this natural aging (we like the patina!).

Although Forever Redwood is maintenance-free, we recommended you take a few minutes as needed to clean by either hosing down and/or brushing/dusting away accumulated debris (no soap or chemicals needed). If you'd like to keep your set looking its best for decades, please go to: [Care and Finish](#).

## IV. MATERIALS

The secret to outdoor longevity begins and ends with the wood. We use generous amounts of the most decay resistant wood available. We encourage our customers to compare photos of our items side by side with any competing product. Thickness counts. Furniture that is thin and light simply won't last in the year round weather.

To keep your furniture beautiful, we use only stainless steel hardware and the highest quality stains and sealants. We use only the Sickens brand of sealants.

Our primary customer has always been the homeowner that appreciates spending a bit more for quality that will last decades.

Our products are installed with organizations that appreciate longevity like the U.S. Forest Service, U.S. military installations, State and City parks, golf clubs and hotels.

We are favored by many landscape architects and contractors because they can count on exceptional quality and quick personal service to complete projects.

We build each item by hand. This insures your set is finely finished and carefully inspected. Old-fashioned hand building also allows us to adjust the size or design of any item to fit your needs.

Because we are a forestry company, we can offer 5 exceptional wood grades to choose from our carefully managed forests with warranties of up to 30 years against decay in any weather. [Click for more about our 5 wood grades.](#)

## V. WARRANTY

Wood decay is warrantied up to 30 years depending on the wood grade. No other outdoor furniture manufacturer has warranties like this. The key is the excellent quality of our wood and the extra-thick timber designs of all our pieces.

### Wood Grades and Decay Warranty:

- Douglas-fir: 10 years
- Mosaic Eco-Wood: 10 years
- Redwood: 15 years
- Mature Redwood: 20 years
- Old-Growth Redwood: 30 years

Forever Redwood stands behind its products. We are committed to quickly resolving any issues that might occur. For more information please see our [Warranty](#) page.

## VI. SHIPPING

### We offer 4 Shipping Options in the U.S.:

- Rush Shipping (ships in 3 weeks).
- Priority Shipping (ships in 6 weeks).
- Standard Shipping (ships in 10 weeks).
- Free Shipping in the Continental U.S. (ships in 14 weeks).

### Notes for Orders requiring drawings or approvals:

All Shade Structure orders (Pergolas, Pavilions, Gazebos and Arbors) require drawings to make sure all details are agreed upon prior to building and to give our customers the ability to customize their structures to meet their needs. We also sometimes make custom changes to Swings, Planters, Benches, Tables and other standard production items per customer requests. If your order has a custom detail or is a shade structure, you will receive your first drawings via email within 5 business days of receiving your completed order with a deposit.

We will go back and forth with you as needed to fine tune the design to your liking prior to building it. Once you sign off on your drawings, your timeline for shipping will begin. Please keep this in mind. If you need a Rush Order and also drawings, it is best you call in your order so that we can organize ourselves to both complete your drawings on an expedited basis and meet your shipping deadline.

**Yes, you can have free shipping plus save 3% off your order!** We carefully hand build each Forever Redwood item. When you choose a longer ship out date, you give us more time to build. This lowers our cost and we pass the savings to you. If you choose the Wait & Save Shipping option and prefer we ship out on a specific date (up to 6 months in advance), just enter the date in the Comment Box at Checkout. If no note is included, we'll ship in 3 months.

Orders ship from San Diego, CA. Add 3 to 6 business days transit time (depending on location).

We ship to any country. Canada orders ship in 6 weeks. To see Canadian shipping costs, just add item to cart.

For orders outside the U.S. or Canada, just enter your country in the shipping information section at checkout or in the shopping cart to see your freight cost. We ship outside the U.S. or Canada in 6 weeks. For all international shipments, the shipping companies handle any customs paperwork and then contact you to arrange delivery.

**Assembly Service Available Nationwide:** All orders over \$3,000. in size can choose to have Forever Redwood assemble for you. Just choose White Glove Service in the Shopping Cart or at Checkout. For more information on White Glove, please go to: [WHITE GLOVE](#).



If your artistically inclined, the crating makes a great canvas to:  
**Lion of the Tribe of Juda by Patricia Vallejo**



Some of the ugly guys from our install crew that will scare your children when they come install your order!